

# **BK PRECISION<sup>®</sup>**

**Model: 9171, 9172, 9173, 9174, 9181,  
9182, 9183, 9184, 9185**

## **Programmable DC Power Supplies**

**USER MANUAL**





## **Safety Summary**

The following safety precautions apply to both operating and maintenance personnel and must be observed during all phases of operation, service, and repair of this instrument. Before applying power, follow the installation instructions and become familiar with the operating instructions for this instrument.

If this device is damaged or something is missing, contact the place of purchase immediately.

This manual contains information and warnings that must be followed to ensure safe operation as well as maintain the meter in a safe condition.

### ***GROUND THE INSTRUMENT***

To minimize shock hazard, the instrument chassis and cabinet must be connected to an electrical ground. This instrument is grounded through the ground conductor of the supplied, three-conductor ac power cable. The power cable must be plugged into an approved three-conductor electrical outlet. Do not alter the ground connection. Without the protective ground connection, all accessible conductive parts (including control knobs) can render an electric shock. The power jack and mating plug of the power cable must meet IEC safety standards.

### ***DO NOT OPERATE IN AN EXPLOSIVE ATMOSPHERE***

Do not operate the instrument in the presence of flammable gases or fumes. Operation of any electrical instrument in such an environment constitutes a definite safety hazard.

## ***KEEP AWAY FROM LIVE CIRCUITS***

Instrument covers must not be removed by operating personnel. Component replacement and internal adjustments must be made by qualified maintenance personnel. Disconnect the power cord before removing the instrument covers and replacing components. Under certain conditions, even with the power cable removed, dangerous voltages may exist. To avoid injuries, always disconnect power and discharge circuits before touching them.

## ***DO NOT SERVICE OR ADJUST ALONE***

Do not attempt any internal service or adjustment unless another person, capable of rendering first aid and resuscitation, is present.

## ***DO NOT SUBSTITUTE PARTS OR MODIFY THE INSTRUMENT***

Do not install substitute parts or perform any unauthorized modifications to this instrument. Return the instrument to B&K Precision for service and repair to ensure that safety features are maintained.

## ***WARNINGS AND CAUTIONS***

***WARNING*** and ***CAUTION*** statements, such as the following examples, denote a hazard and appear throughout this manual. Follow all instructions contained in these statements.

A ***WARNING*** statement calls attention to an operating procedure, practice, or condition, which, if not followed correctly, could result in injury or death to personnel.

A **CAUTION** statement calls attention to an operating procedure, practice, or condition, which, if not followed correctly, could result in damage to or destruction of part or all of the product.

**WARNING:** *Do not alter the ground connection. Without the protective ground connection, all accessible conductive parts (including control knobs) can render an electric shock. The power jack and mating plug of the power cable meet IEC safety standards.*

**WARNING:** *To avoid electrical shock hazard, disconnect power cord before removing covers. Refer servicing to qualified personnel.*

**CAUTION:** *Before connecting the line cord to the AC mains, check the rear panel AC line voltage indicator. Applying a line voltage other than the indicated voltage can destroy the AC line fuses. For continued fire protection, replace fuses only with those of the specified voltage and current ratings.*

**CAUTION:** *This product uses components which can be damaged by electrostatic discharge (ESD). To avoid damage, be sure to follow proper procedures for handling, storing and transporting parts and subassemblies which contain ESD-sensitive components.*

# Compliance Statements

**Disposal of Old Electrical & Electronic Equipment (Applicable in the European**

**Union and other European countries with separate collection systems)**



**This product is subject to Directive 2002/96/EC of the European Parliament and the Council of the European Union on waste electrical and electronic equipment (WEEE) , and in jurisdictions adopting that Directive, is marked as being put on the market after August 13, 2005, and should not be disposed of as unsorted municipal waste. Please utilize your local WEEE collection facilities in the disposition of this product and otherwise observe all applicable requirements.**

# CE Declaration of Conformity

The power supplies models 9171, 9172, 9173, 9174, 9181, 9182, 9183, 9184, 9185 meet the requirements of 2006/95/EC Low Voltage Directive and 2004/108/EC Electromagnet Compatibility Directive with the following standards.







## Low Voltage Directive

- EN61010-1: 2001  
Safety requirements for electrical equipment for measurement, control, and laboratory use.  
Part 1: General requirements

## EMC Directive

- EN 61000-3-2: 2006
- EN 61000-3-3: 1995+A1: 2001+A2: 2005
- EN 61000-4-2: 1995+A1: 1998+A2: 2001
- EN61000-4-3: 2006+A1: 2008
- EN61000-4-4: 2004
- EN61000-4-5: 2006
- EN61000-4-6: 2007
- EN61000-4-11: 2004
- EN 61326-1: 2006  
Electrical equipment for measurement, control, and laboratory use.

# Safety Symbols

	Refer to the user manual for warning information to avoid hazard or personal injury and prevent damage to instrument.
	Chassis (earth ground) symbol.
	On (Power). This is the In position of the power switch when instrument is ON.
	Off (Power). This is the Out position of the power switch when instrument is OFF.
	On (Supply). This is the AC mains connect/disconnect switch at the back of the instrument.
	Off (Supply). This is the AC mains connect/disconnect switch at the back of the instrument.



# Table of Contents

---

<b>1</b>	<b>General Information .....</b>	<b>1</b>
1.1	Product Overview .....	1
1.2	Package Contents.....	2
1.3	Front Panel Overview.....	3
	<i>Front Panel Description.....</i>	<i>5</i>
1.4	Rear Panel Overview.....	6
	<i>Rear Panel Description.....</i>	<i>8</i>
1.5	Optional Accessories.....	8
	<i>Interface Card Options.....</i>	<i>8</i>
	<i>Rack mount Options.....</i>	<i>9</i>
1.6	Display Overview .....	9
	<i>Display Description .....</i>	<i>10</i>
1.7	Installing Optional Interface Cards .....	10
	<i>How to Install Interface Cards.....</i>	<i>11</i>
	<i>Removing Interface Cards.....</i>	<i>12</i>
1.8	Rackmount Installation .....	13
<b>2</b>	<b>Getting Started.....</b>	<b>19</b>
2.1	Input Power and Fuse Requirements .....	19
	<i>Input Power.....</i>	<i>19</i>
	<i>Fuse Requirements.....</i>	<i>19</i>
2.2	Line Voltage Selection.....	20
2.3	Output Connections.....	22
2.4	Preliminary Check .....	24
	<i>Output Check .....</i>	<i>26</i>
	<i>Check Model and Firmware Version .....</i>	<i>28</i>
<b>3</b>	<b>Front Panel Operation.....</b>	<b>29</b>

3.1	Menu Options .....	29
	<i>How to Access the Menu</i> .....	30
3.2	Remote Interface Setup .....	33
	<i>USB Interface (virtual COM)</i> .....	33
	<i>GPIB Interface</i> .....	35
	<i>Ethernet (LAN) Interface</i> .....	35
	<i>RS-232 and RS-485 Interface (Optional)</i> .....	36
3.3	Adjusting LCD Display, Key Lock, Key Sound .....	39
	<i>LCD Backlight Timer</i> .....	40
	<i>Key Lock</i> .....	40
	<i>Disabling Key Sound</i> .....	41
3.4	Restore to Factory Default .....	41
3.5	Configure Voltage and Current Output.....	43
	<i>Voltage and Current Limit Settings</i> .....	43
	<i>Configure Voltage and Current Output</i> .....	46
	<i>Slew Rate Configuration</i> .....	51
	<i>Output Timer Function</i> .....	53
	<i>Measurement Average Setting</i> .....	55
3.6	Dual Channel Configurations .....	56
	<i>Multi/Single Output Control</i> .....	56
	<i>Series/Parallel Tracking Mode</i> .....	57
3.7	Remote Sense .....	57
3.8	LED and Low Current Test Modes .....	62
	<i>LED Mode</i> .....	62
	<i>Low Current Mode</i> .....	64
3.9	Output Protection .....	66
	<i>Configure OVP</i> .....	66
	<i>Configure OCP</i> .....	67

3.10	Save/Recall Output Settings .....	68
3.11	Sequence Program Mode .....	71
3.12	External Analog Control .....	72
3.13	Digital I/O .....	77
	<i>INPUT</i> .....	79
	<i>OUTPUT</i> .....	80
3.14	Display Errors .....	81
3.15	Connecting in Series and Parallel .....	82
<b>4</b>	<b>Remote Operation .....</b>	<b>83</b>
4.1	Interface Connection .....	83
	<i>USB (Virtual COM) &amp; RS-232</i> .....	83
	<i>GPIB</i> .....	84
	<i>Ethernet (LAN)</i> .....	85
4.2	Remote Commands .....	90
	<i>Parameter Definitions</i> .....	91
	<i>Remote Commands</i> .....	91
4.3	Sequence Programming .....	134
	<i>Examples</i> .....	134
4.4	Multi Unit Programming .....	138
	<i>Remote Commands via USB</i> .....	139
<b>5</b>	<b>Troubleshooting Guide .....</b>	<b>151</b>
	<i>General</i> .....	151
	<i>Remote Control</i> .....	153
<b>6</b>	<b>Specifications .....</b>	<b>154</b>
<b>7</b>	<b>Calibration .....</b>	<b>159</b>
	<i>Access Calibration Menu</i> .....	159
	<i>Requirements</i> .....	159
	<i>Current Calibration</i> .....	160

<i>Voltage Calibration</i> .....	163
<i>External Analog Input Calibration</i> .....	165
<b>Index</b> .....	<b>170</b>
<b>SERVICE INFORMATION</b> .....	<b>171</b>
<b>LIMITED THREE-YEAR WARRANTY</b> .....	<b>172</b>

# 1 General Information

## 1.1 Product Overview

The 917x and 918x series are high-performance dual range linear DC power supplies that provide clean and reliable power with high resolution and accuracy. All models are programmable via standard USB interface or optional RS232, GPIB and LAN interface. Interface cards and I/O cards come in a modular form factor. Selected models feature high voltage outputs or dual channels to provide series/parallel tracking functionality. All models include front and rear panel outputs for flexibility, and feature programmable list mode for storing and running customized test sequences. Additionally, a unique LED test mode function can be enabled for LED test applications requiring minimal inrush current output. These power supplies are suitable for bench or rack mount operation with the available rack mount kit option.

### Features

- Single and dual output models with up to 210W output power
- High accuracy and low noise output
- Dual range output with automatic range selection (except of high voltage models 9184 and 9185)
- Fast transient response of < 50  $\mu$ s of most models
- Very low ripple and noise
- LED test mode for low inrush current output
- Programmable list mode for creating test sequences
- Front and rear remote sense terminals for single output models (except of high voltage models 9184 and 9185)
- OVP, OCP, and OTP protection
- Two interchangeable interface slots accepting any of the following optional interface cards: LAN/GPIB, Digital I/O and Analog control, RS485, RS232
- Standard USB interface (virtual COM)
- Programmable voltage and current slew rates

## **1.2 Package Contents**

Please inspect the instrument mechanically and electrically upon receiving it. Unpack all items from the shipping carton, and check for any obvious signs of physical damage that may have occurred during transportation. Report any damage to the shipping agent immediately. Save the original packing carton for possible future reshipment. Every power supply is shipped with the following contents:

- **917x/918x Power supply**
- **User Manual**
- **AC Power Cord**
- **USB Type A to Type B Cable**
- **Line fuse (for 115V or 230V operation)**
- **Certificate of Calibration**
- **Test Report**

Verify that all items above are included in the shipping container. If anything is missing, please contact B&K Precision.

# 1.3 Front Panel Overview

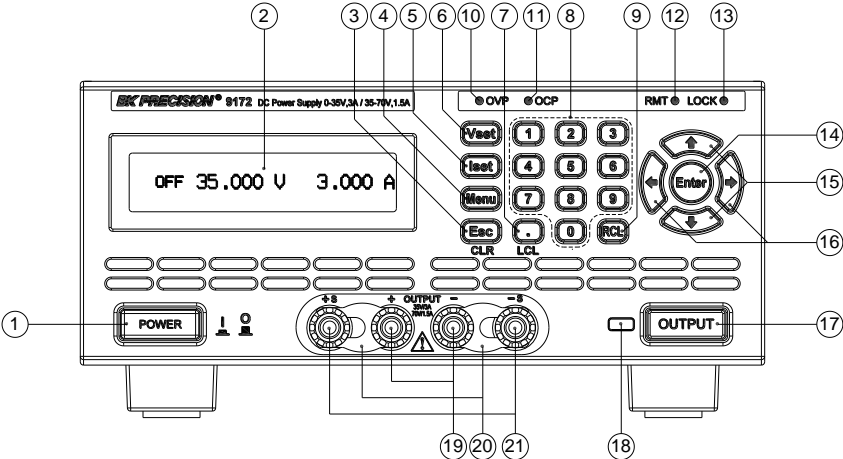

Figure 1 - Front Panel for 9171/9172/9181

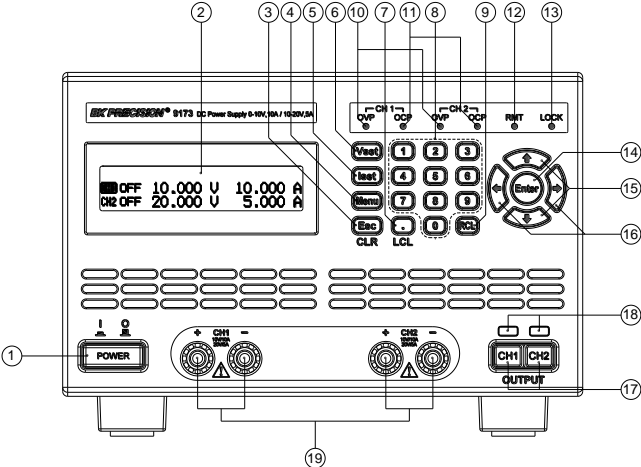
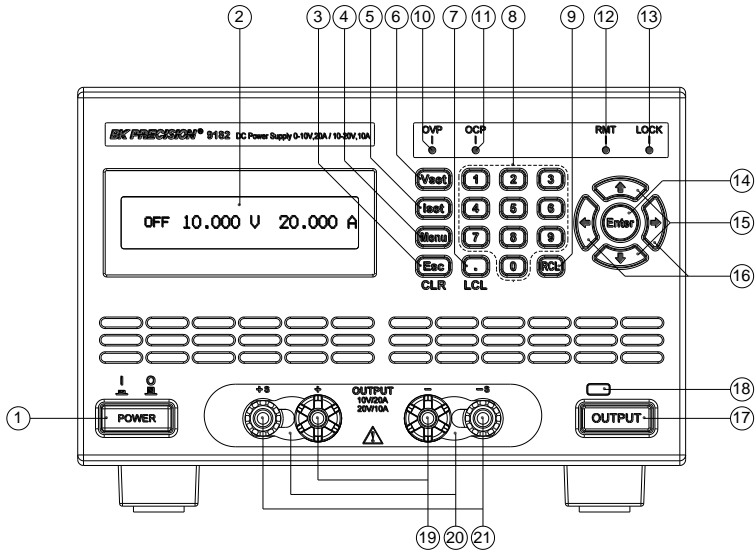
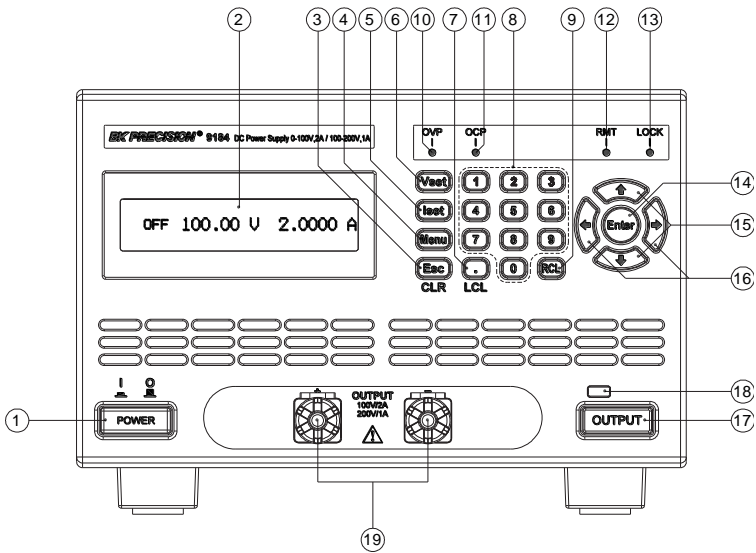

Figure 2 - Front Panel for 9173/9174



**Figure 3 - Front Panel for 9182/9183**



**Figure 4 - Front Panel for 9184/9185**



## ***Front Panel Description***

- 
- ① Power ON/OFF button

---

  - ② LCD display

---

  - ③ Esc / CLR button

---

  - ④ Menu button

---

  - ⑤ ISET button

---

  - ⑥ VSET button

---

  - ⑦ Decimal/LCL(Local) button

---

  - ⑧ Numeric keypad

---

  - ⑨ RCL (Recall) button

---

  - ⑩ OVP indicator

---

  - ⑪ OCP indicator

---

  - ⑫ RMT (Remote mode) indicator

---

  - ⑬ LOCK (Key lock) indicator

---

  - ⑭ Enter button

---

  - ⑮ Up, Down arrow keys

---

  - ⑯ Left, Right arrow keys

---

  - ⑰ Output button (Dual channel models have CH1 and CH2 output buttons)

---

  - ⑱ Output ON/OFF indicator light

---

  - ⑲ Main output terminals (Models 9182,9184,9185 have larger binding post terminals for high current/voltage outputs)

---

  - ⑳ Front terminal shorting bars

---

  - ㉑ Front panel +S/-S sense terminals (Not available with models 9173, 9174, 9184, 9185)
-

# 1.4 Rear Panel Overview

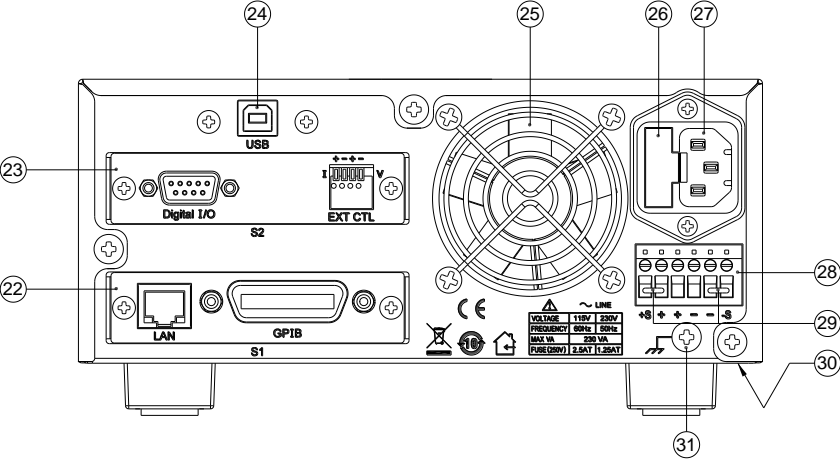

Figure 5- Rear View for 9171/9172/9181

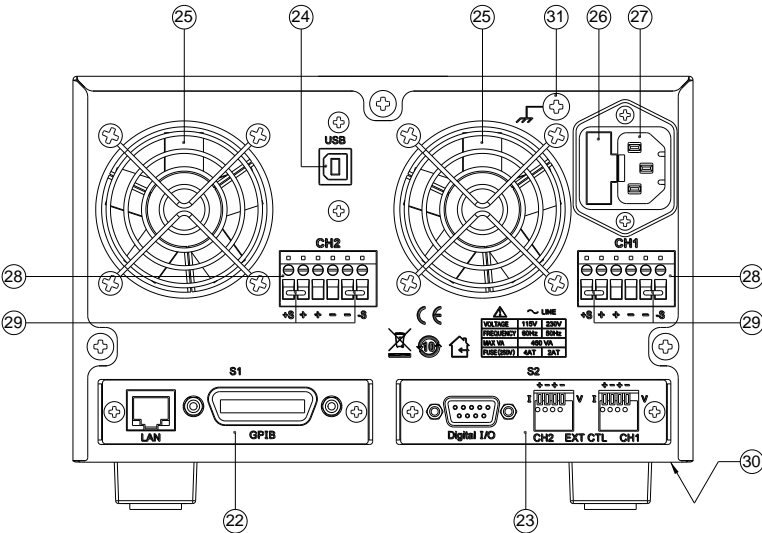
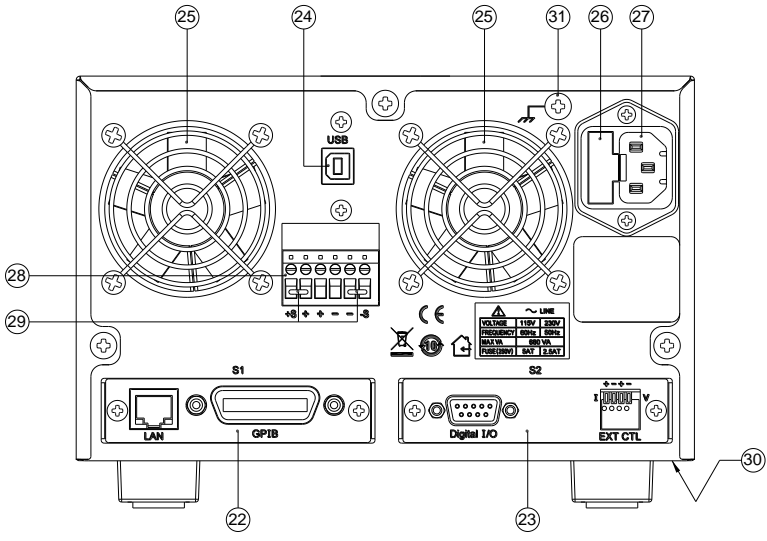
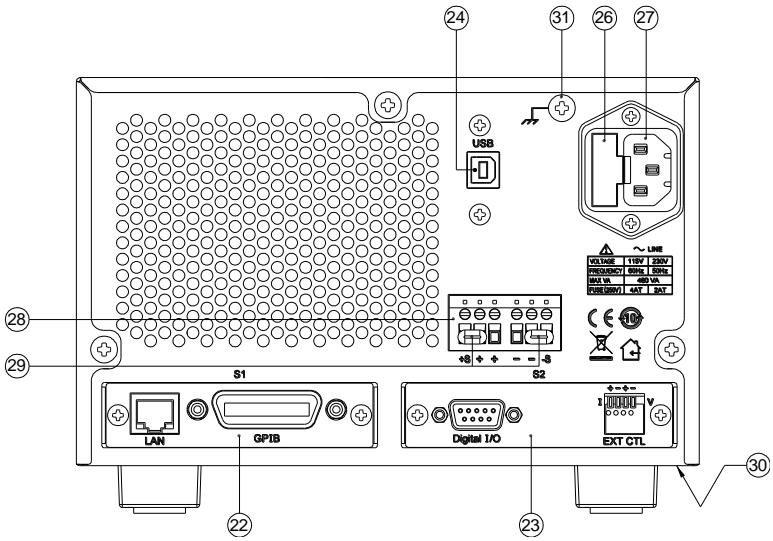

Figure 6- Rear View for 9173/9174



**Figure 7- Rear View for 9182/9183**



**Figure 8- Rear View for 9184/9185**

## ***Rear Panel Description***

- 
- ②② S1 interface slot (shown with optional LAN/GPIB interface card)

---

  - ②③ S2 interface slot (shown with optional DIO/Analog interface card)

---

  - ②④ USB interface

---

  - ②⑤ Temperature controlled cooling fan(s)

---

  - ②⑥ AC input fuse box

---

  - ②⑦ Line input receptacle

---

  - ②⑧ Rear panel outputs (++) and sense (+S/-S) terminals

---

  - ②⑨ Shorting pins

---

  - ③⑩ Line voltage selection switch (bottom of power supply) See “2.2Line Voltage Selection” for details.

---

  - ③① Chassis ground
- 

## **1.5 Optional Accessories**

The following lists all optional accessories supported by the 917x/918x series power supplies.

### ***Interface Card Options***

<b>Model</b>	<b>Description</b>
DRGL	GPIB/LAN interface card
DR1DIO	Single channel digital I/O and analog control card
DR2DIO	Dual channel digital I/O and analog control card
DRRS485	RS485 interface card
DRRS232	RS232 interface card

## ***Rack mount Options***

Rackmount kits are available for all 9 models. Refer to the following to determine your power supply rack mount size.

**2U size: Models 9171, 9172, 9181**

**3U size: Models 9173, 9174, 9182, 9183, 9184, 9185**

<b>Model</b>	<b>Description</b>
DRRM2U1	Rackmount kit for single 2U power supply
DRRM2U2	Rackmount kit for two 2U power supplies mounted side by side
DRRM3U1	Rackmount kit for single 3U power supply
DRRM3U2	Rackmount kit for two   3U power supplies mounted side by side

## **1.6 Display Overview**

The main displays for single and dual channel models are shown below.

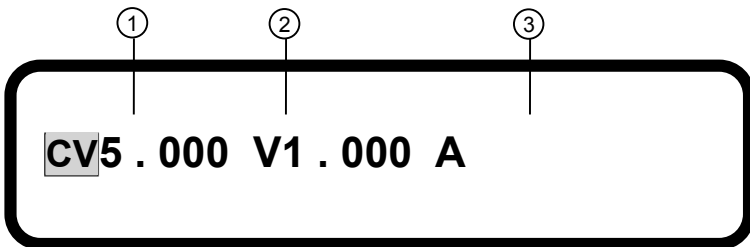

**Figure 9- Main Display**

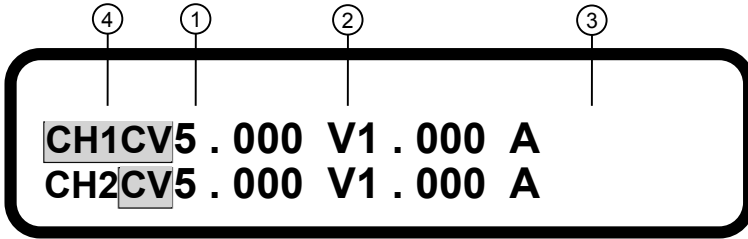

Figure 10- Dual Channel Main Display

## Display Description

- 
- ① Output Mode (CV, CC, OFF)
- 
- ② Voltage display (When output is OFF, it shows VSET voltage. When output is ON, it shows measured voltage)
- 
- ③ Current display (When output is OFF, it shows ISET current. When output is ON, it shows measured current)
- 
- ④ Selected channel indicators
- 

## 1.7 Installing Optional Interface Cards

Five optional interface cards are available and can be installed in either the **S1** or **S2** slots. They are:

### Option 1: GPIB/LAN Card

*Adds GPIB and LAN interface*

### Option2: DIO/Analog Card (Single channel)

*Adds digital I/O and External Analog Control*

### Option 3: DIO/Analog Card (Dual channel)

*Adds dual channel digital I/O and External Analog Control*

### Option 4: RS485 Card

*Adds RS-485 interface for multi power supply control*

### **Option 5: RS232 Card**

*Adds RS-232 interface*

## ***How to Install Interface Cards***

1. Power off the instrument and disconnect the AC power cord in the rear panel. Remove the back faceplate covering the **S1** or **S2** slot in the rear panel by removing the two screws on each side.

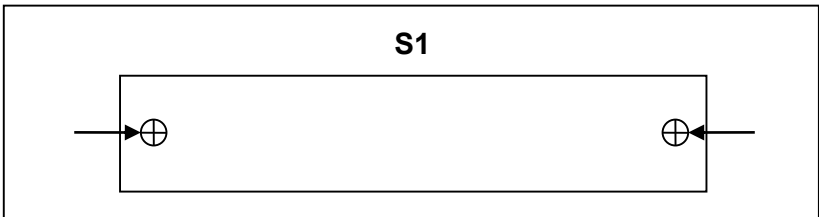

2. Make note of the metal notches that indicate where the card should slide into. Inside the slot, there are two rails (left and right side) where the card should slide smoothly into. The very back of the slot is a 48-pin female connector that should connect with the 48-pins on the back of the interface card.

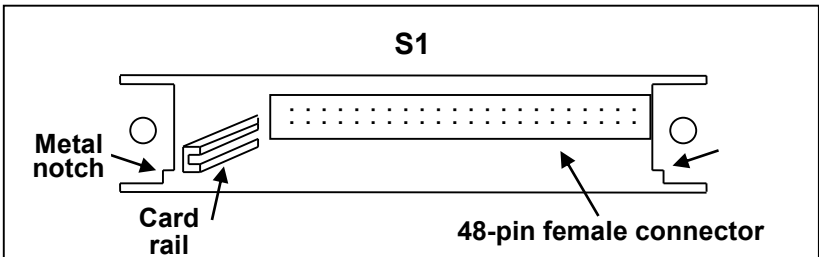

3. The interface card should go right below the metal notches on both sides and fit in between the inner card rails, also on

both sides. Slide the card down carefully. When it touches the 48-pin connector, slowly push the card all the way in until the panel of the interface card aligns with the rear panel of the power supply.

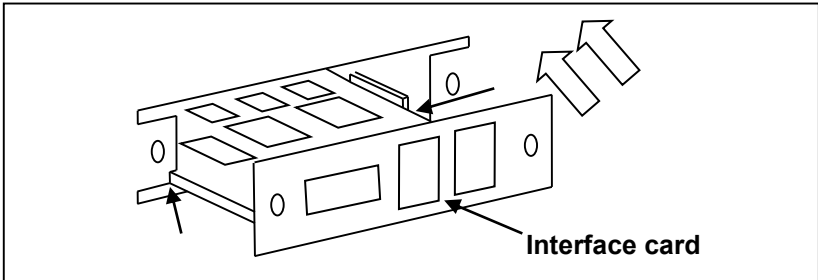

4. Place the two screws to tighten and secure the installed card.
5. Connect the power cord and turn on the power supply. The newly installed card will be detected during boot up, indicated next to **S1**: or **S2**: (depending on which slot the card is installed into).

## ***Removing Interface Cards***

1. Power off the instrument and disconnect the AC power cord in the rear panel. Remove the two screws on each side of the installed interface card.

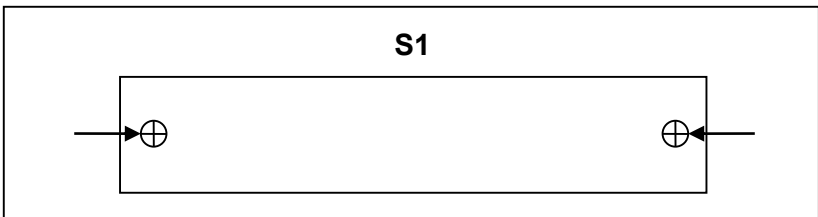

2. Use a flat blade screwdriver to gently pry the left and right side of the interface card plate. When there is enough room,



use the screwdriver to pry the top part of the card until the card has slid out with enough room to pull out the card by hand.

3. Be sure to ground yourself before pulling out or touching any parts of the printed board on the interface card.

## 1.8 Rackmount Installation

There are four rackmount kit options available for this series of power supplies: 2U size for single power supply, 2U size for two power supplies mounted side by side, 3U size for single power supply, 3U size for two power supplies mounted side by side. The following step by step instructions will guide you in installing these optional rackmount kits onto the power supply for a standard 19-inch rack fitting.

**Models 9171, 9172, 9181:** Follow instructions for 2U rackmount installation.

**Models 9173, 9174, 9182, 9183, 9184, 9185:** Follow instructions for 3U rackmount installation.

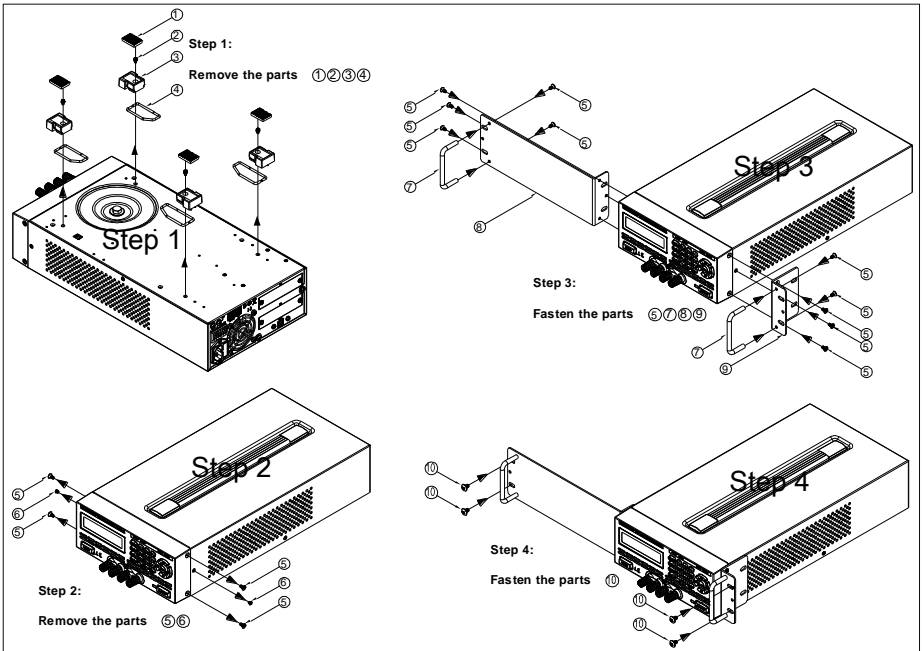

**Figure 11- 2U Single Supply Rackmount Installation**

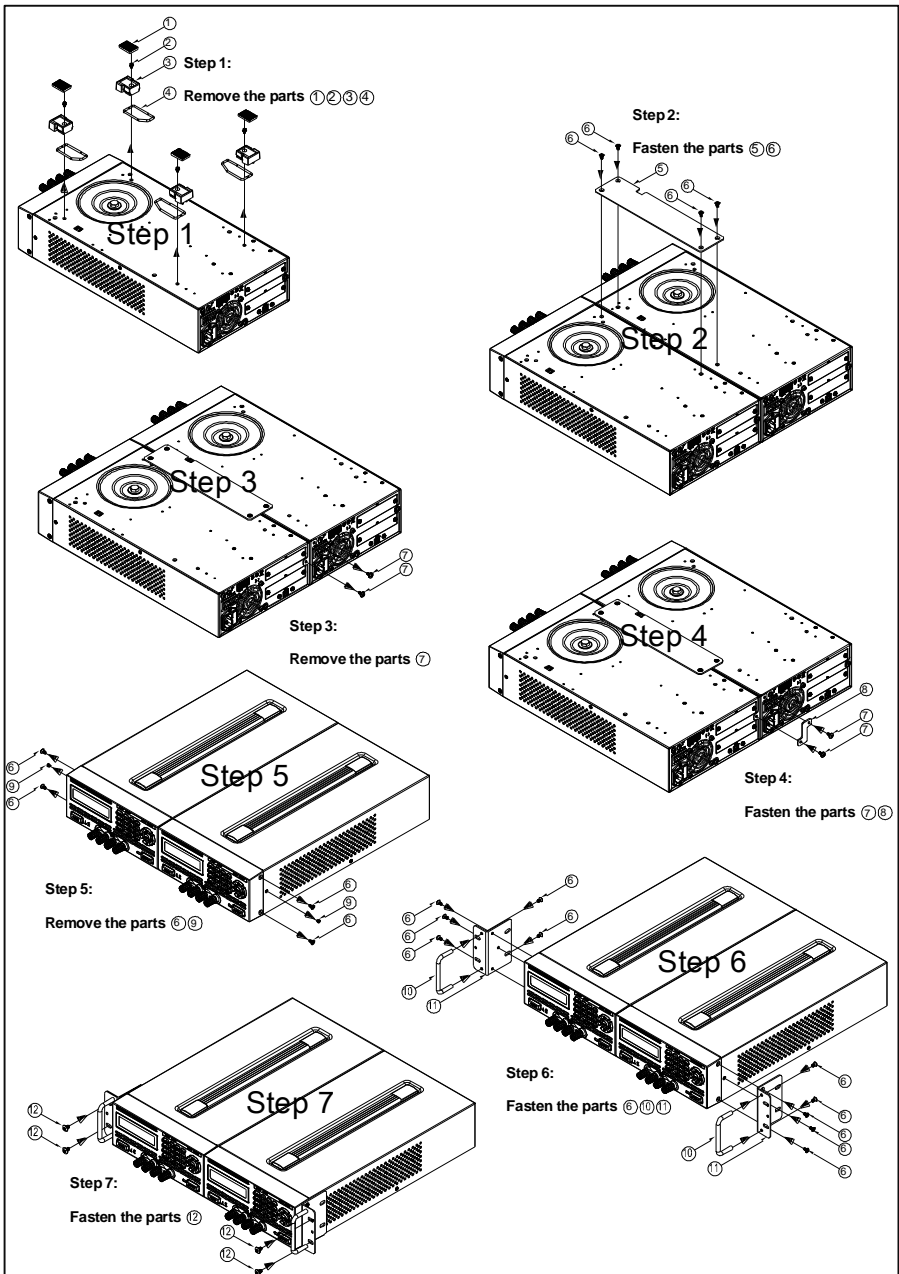

**Figure 12- 2U Dual Supplies Rackmount Installation**

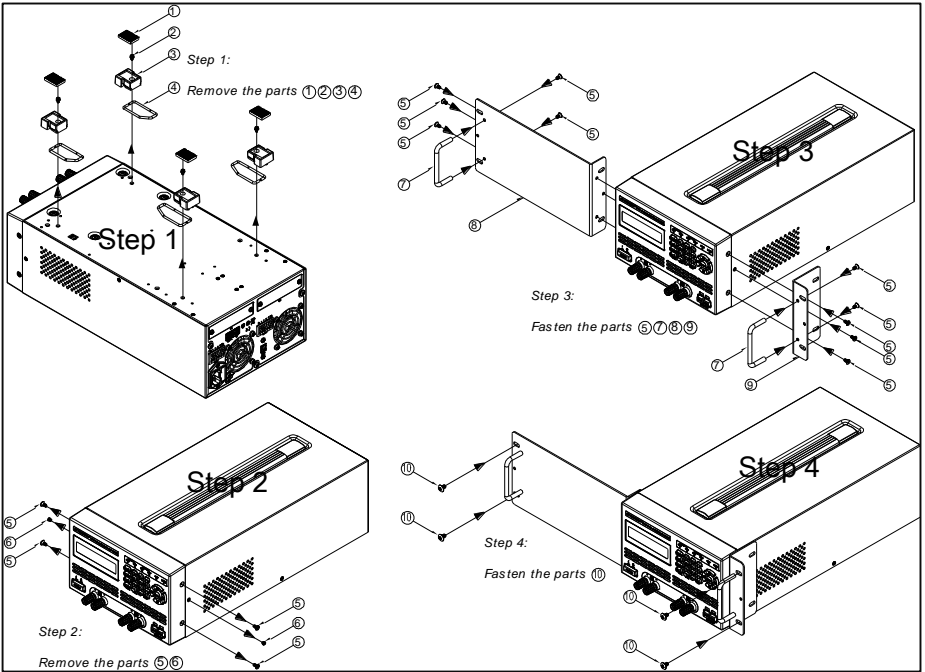

**Figure 13- 3U Single Supply Rackmount Installation**

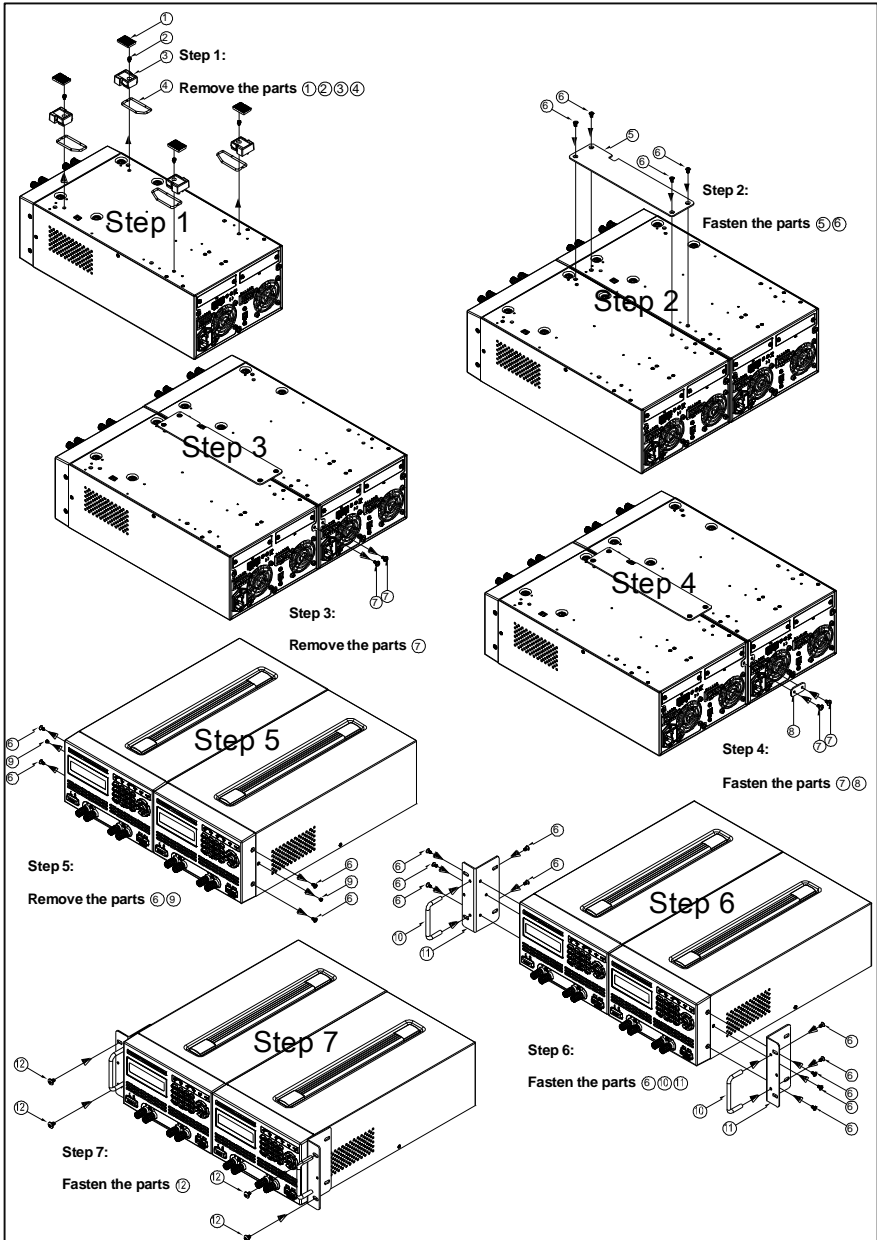

**Figure 14–3U Dual Supplies Rackmount Installation**



## 2 Getting Started

### 2.1 Input Power and Fuse Requirements

#### *Input Power*

The rated AC input power source for powering the supplies must be within:

115V Operation: **103.5V-126.5V**

230V Operation: **207V - 253V**

Frequency: **47 Hz – 63 Hz**

Before connecting to an AC outlet or external power source, be sure that the power switch is in the OFF position and verify that the AC power cord, including the extension line, is compatible with the rated voltage/current and that there is sufficient circuit capacity for the power supply. Once verified, connect the cable firmly.

---

#### **WARNING:**

**The included AC power cord is safety certified for this instrument operating in rated range. To change a cable or add an extension cable, be sure that it can meet the required power ratings for this instrument. Any misuse with wrong or unsafe cables will void the warranty.**

---

#### *Fuse Requirements*

An AC input fuse is necessary when powering the instrument.

Below is a table showing the required fuses for AC line input 115V and 230V operation for all models.

**Table 1- Input Fuse Table**

<b>Model</b>	<b>115 V AC</b>	<b>230 V AC</b>
9171	2.5 A	1.25 A
9172	2.5 A	1.25 A
9173	4 A	2 A
9174	4 A	2 A
9181	3.15 A	1.6 A
9182	5 A	2.5 A
9183	4 A	2 A
9184	4 A	2 A
9185	4 A	2 A

**Note: All fuses listed have the specifications: T250V, slow blow (slow acting), 5 x 20mm.**

## **2.2 Line Voltage Selection**

The power supplies can be selected to operate with 115V input or 230 V input. To ensure that your instrument is properly configured to operate at the desired AC line voltage, please follow the steps below:

---

### **CAUTION:**

**For safety, no power should be applied to the instrument while changing line voltage operation. Disconnect all cables connected to the instrument before proceeding.**

---



## Step 1 - Check and/or Change Fuse

- Locate the fuse box next to the AC input connector in the rear panel.
- With a small flat blade screwdriver, insert into the fuse box slit to pull and slide out the fuse box as indicated below.
- Check and replace fuse (if necessary) for the desired line voltage operation (see Table 1).

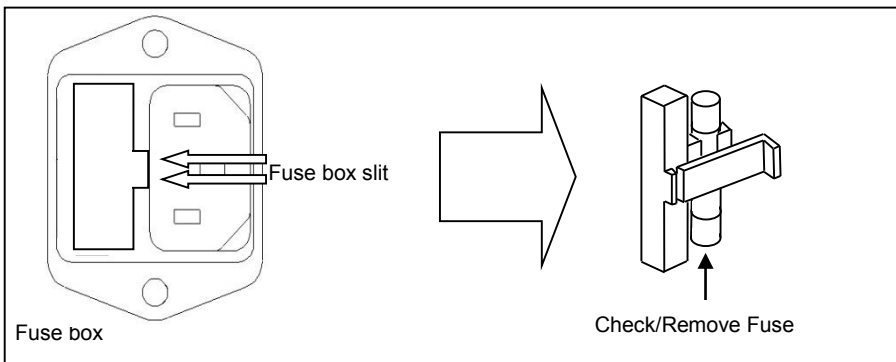

## Step 2 - Check and/or Change Line Voltage Switch

- Carefully lift and turn the instrument upside down.
- Locate the red Line Voltage Switch, which has markings that indicate “**115**” for 115V or “**230**” for 230V line operation. Set the switch to the desired line voltage operation.

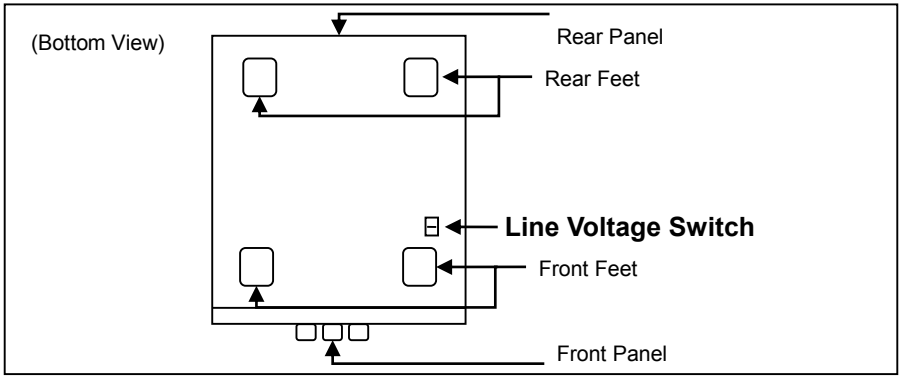

**WARNING:**

**Do not connect power to the instrument until the line voltage selection is setup correctly. Applying an incorrect line voltage or configuring the line voltage selection improperly may damage the instrument and void all warranty.**

## 2.3 Output Connections

These power supplies have both front panel binding posts and rear panel terminals for output connections, and they are paralleled together. The two (+) and two (-) (per channel for dual channel models) rear output terminals can accept wire sizes AWG 24 to AWG 12 (See Table 2). However, we recommend using 12 AWG if current output is between 5 to 10 A. For current output above 10 A, remove the shorting bars from the front panel, but do not remove the shorting pins on the rear panel. Use two separate wires/leads to connect both (+) terminals and (-) terminals as shown below:

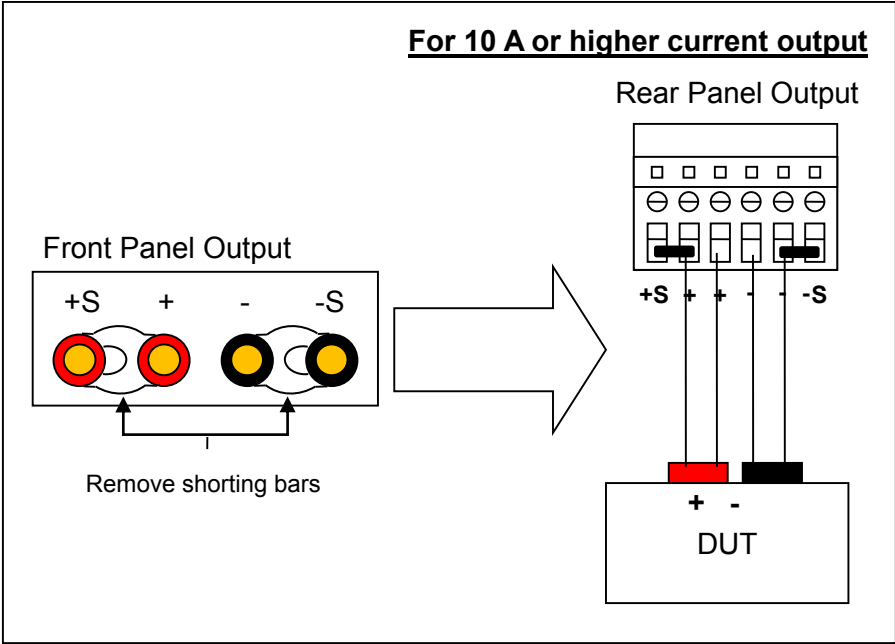

**WARNING:**

**DO NOT output 10 A or more with only one pair of (+) and (-) terminals. Both (+) and (-) terminals must all be connected for applications requiring more than 10 A output. Each terminal can only accept a maximum of 10 A. Exceeding this may damage the power supply.**

**Table 2- Wire Gauge Rating**

AWG	10	12	14	16	18	20	22	24	26	28
$I_{max}(A)$	40	25	20	13	10	7	5	3.5	2.5	1.7
$m\Omega/meter$	3.3	5.2	8.3	13.2	21	33.5	52.8	84.3	133.9	212.9

---

**WARNING:**

**Before connecting wires to the front or rear panel output terminals, turn OFF the power supply to avoid damage to the instrument and the device under test (DUT). For safety, load wires must have a wire gauge size large enough to prevent overheating when the power supply operates at maximum short circuit output current. It will also prevent large voltage drops from resistances in the wires.**

---

## 2.4 Preliminary Check

Complete the following steps to verify that the power supply is ready for use.

### 1. Verify Line Voltage Selection

Complete the steps as described in “2.2 Line Voltage Selection” to make sure the supply is correctly setup to operate with the line voltage source to be used.

### 2. Connect Power and Self Test

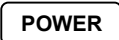
Connect AC power cord to the AC receptacle in the rear panel and press  on the instrument. It will run through a self test procedure, as well as check for installed interface cards. The following screens will display before it's ready for use (Display will vary based on the model and installed interface cards)

**SRAM TEST ..... OK**  
**MAIN TEST .....OK**

**CHECKING FOR EEPROM DATA**



**CHECKING FOR OPTION CARD . .**  
**S1 : GPIB/LAN CARD**  
**S2 : RS485**

**B&K PRECISION**  
**9181**  
**VER : 2.00**

# Output Check



## Voltage Check

Follow the steps below to check basic voltage output with no load connected.

1. Turn on the power supply. The display will show the **OFF** annunciator next to the setting voltage on the left side of the display.
2. Enable the output by pressing **OUTPUT** (or **CH1** and **CH2** for dual channel models). The output indicator light will be lit and display will show the measured output voltage. The **OFF** annunciator will change to **CV**.
3. Using the numeric keypad, press **Vset** and enter a voltage value. Then press the **Enter** key. For dual channel models, select the channel first before setting the voltage. The selected channel is indicated by a flashing **CH1** or **CH2** annunciator on the display. Press  or  to select the channel.
4. The measured output voltage should change to a value close to or exactly what you entered (For example, if voltage value is 30.000 V, it may show 29.998 V).
5. (Optional) You may also verify the output voltage by connecting either the (+) and (-) terminals on the front panel or the rear panel to an external voltmeter. The measured value should match or be close to the entered voltage value.

## Current Check

Follow the steps below to check basic current output of the power supply.

1. Turn on the power supply. The display will show the **OFF** annunciator next to the setting voltage on the left side of the display.
2. Short the (+) and (-) output terminals with test leads, shorting bar, or clip. (Refer to Table 2 to select appropriate test leads)
3. Enable the output by pressing **OUTPUT** (or **CH1** and **CH2** for dual channel models). The output indicator light will be lit and display will show the measured output voltage. The **OFF** annunciator will change to **CC**.
4. Using the numeric keypad, press **Iset** and enter a current value. Then press the **Enter** key. For dual channel models, select the channel first before setting the voltage. The selected channel is indicated by a flashing **CH1** or **CH2** annunciator on the display. Press  or  to select the channel.
5. The measured output current should change to a value close to or exactly what you entered (For example, if current value is 5.0000 A, it may show 4.9998 A).
6. (Optional) You may also verify the output current by connecting either the (+) and (-) terminals on the front panel or the rear panel to an external current meter capable of measuring the current that you set. The measured value should match or be close to the entered current value.

7. Press **POWER** to turn off the power supply and remove the short on the output terminals.

## ***Check Model and Firmware Version***

The model and firmware version can be verified from one of the boot up screens, or from using the **\*IDN?** query remote command, described in “4.2 Remote Commands”. Additionally, other system version and information can be found by following the steps below:

1. Press **Menu**, then **8** to enter **INFORMATION**. The following screen will be displayed.

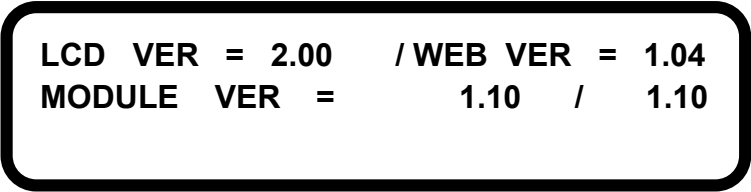

The screenshot shows a black rounded rectangle containing white text. The text is arranged in two lines. The first line reads 'LCD VER = 2.00 / WEB VER = 1.04'. The second line reads 'MODULE VER = 1.10 / 1.10'. The text is centered within the rectangle.

```
LCD VER = 2.00 / WEB VER = 1.04
MODULE VER = 1.10 / 1.10
```

2. There are multiple version numbers shown. However, the firmware version is displayed under **MODULE VER**. In the example screen above, firmware version is shown as 1.10.
3. Press **Esc** twice to exit the menu.



# 3 Front Panel Operation

## 3.1 Menu Options

All settings and parameters can be configured from the built-in menu system of the power supply. To access the menu, press **Menu** . The menu system is divided into 8 categories and organized as follows:

### 1. SYSTEM SETTING

- REMOTE(*USB,ETHERNET,GPIB,RS232 (optional)*)
- GPIB ADDR(*1-30*)
- KEY LOCK(*ON,OFF*)
- IP CONFIG(*STATIC*)
- IP ADDRESS(*xxx.xxx.xxx.xxx, where x = 0-9*)
- BEEP(*ON,OFF*)
- LCD BACKLIT(*ALWAYS ON, 1,5,10,30 MINS OFF*)
- RECALL DEFAULT(*NO,YES*)
- POWER ON STATE (*OFF,LAST*)
- OUTPUT MODE (*MULTI,SINGLE*)\*
- TRACKING MODE (*ON,OFF*)\*
- EXTERN CONTROL (*VOLT,RES,OFF*) (*optional*)
- EXTERN LEVEL (*5V,10V*) (*optional*)
- EXTERN TRIG (*ON,OFF*) (*optional*)

### 2. OUTPUT SETTING

1. VOLT LIMIT SETTING
  - VOLT LIMIT MAX (*0 – Max. Voltage*)
  - VOLT LIMIT MIN (*0 – Max. Voltage*)
2. CURR LIMIT SETTING
  - CURR LIMIT MAX (*0 – Max. Current*)
  - CURR LIMIT MIN (*0 – Max. Current*)
3. VOLT SLEWRATE SETTING
  - V SLEWRATE
4. CURR SLEWRATE SETTING
  - I SLEWRATE
5. MEASURE AVERAGE(*1-10*)
6. LED MODE SETTING
  - LED MODE (*ON,OFF*)

- Low Current Mode (ON,OFF)\*\*
3. PROTECTION
    1. OVP SETTING
      - OVP (ON,OFF)
      - SET (0 – Max. Voltage)
    2. OCP SETTING
      - OCP (ON,OFF)
      - SET (0 – Max. Current)
  4. MEMORY SETTING(0-9)
  5. PROGRAM MODE
  6. TIMER FUNCTION
    - TIMER (ON,OFF)
    - TIME (hr:min:sec)
  7. CALIBRATION
  8. INFORMATION
  9. CHAIN SETTING (optional)
    - CHAIN ON/OFF (ON,OFF)
    - CHAIN ADDRESS(1-31)

*\*Dual channel models 9173 and 9174 only.*

*\*\*Models 9184 and 9185 only.*

---

**Note:** All optional menu items appear only when their respective optional interface cards are installed inside the power supply.

---

## ***How to Access the Menu***

Before using the instrument, it is important to be familiarized with its menu structure and how to view or change settings and parameters. Follow the steps below to guide you in selecting menu options.



---

**Note:** The menu cannot be accessed when the output(s) is turned ON or when it is in remote mode (indicated by **RMT** light).

---



1. From the front panel, press **Menu** to enter the main menu and the below screen will display. The ▼ on the bottom right indicates that there are more categories below that can be displayed.







2. Press  to display those categories. The ▲ on the upper right indicates that there are categories above the current displayed categories shown. Press  and the screen will display the previous menu categories.



3. Each main category, as well as some submenu items within the category, has a number next to their respective category heading. Whenever you see a number next to a menu item (i.e. 1. SYSTEM SETTING, 4. MEMORY SETTING), use the numeric keypad to enter that number to access that category's menu or submenus. For example, press **1** to access the **SYSTEM SETTING** menu.
4. Within the category menus or submenus, adjustable settings and parameters will have a cursor (indicated by an underline of a digit or character) to indicate the current selection. Use

the  and  keys to select the setting you want to change. Below is an example of the **Remote** settings being selected. Note the underline below the first character of the setting “USB”.

REMOTE	=	<u>U</u> SB	
GPIB ADDR	=	1	
KEY LOCK	=	OFF	

- Settings have selectable options that are not numeric (i.e. REMOTE settings shown above). To change them, press  or . To save the changes, press the .
- Parameters have numerical set values (i.e. GPIB ADDR parameter shown above). To change them, use the numeric keypad to enter the value you want to change to. To save the changes, press the  key.

---

**Note:** Changes to settings and parameters apply only when the  key is pressed to confirm the changes. Otherwise, they will default to previous set option or value.

---



## 3.2 Remote Interface Setup



The standard remote interface available on all models in the series is the USB (virtual COM) interface. Other optional supported interfaces such as GPIB, Ethernet (LAN), RS-232, and RS-485 are available, but dependent on the interface card(s) installed on the instrument. This section will describe how to setup all the supported interfaces.

**Note:** The **RMT** LED will automatically light up when the power supply is successfully connected to a PC remotely through any remote interface. Keys on the front panel will be locked until  (**LCL**) is pressed to set the instrument back to LOCAL mode.

### ***USB Interface (virtual COM)***

The USB interface comes standard on every power supply in the series. A **USB Type A to Type B cable** (i.e. USB printer cable) is required to connect the USB port (  ) in the rear panel to a PC. Follow the steps below to setup the power supply for USB (virtual COM) remote communication.

1. Press , then  to enter **SYSTEM SETTING**. Select **REMOTE** and verify that it shows **USB**, which is the default

option. If not, press  or  until "**USB**" is displayed.

Press  to save changes.

2. Install the USB driver. Visit [www.bkprecision.com](http://www.bkprecision.com) to download the driver. Run the setup executable after unzipping the downloaded file.

---

**Note:** Do this before connecting the USB cable from the power supply to the PC.

---

3. Once the installation is successful, connect the USB cable between the power supply and the PC. Drivers should be automatically recognized. To verify, go to “Device Manager” in Windows, and under “Ports (COM & LPT)”, a new device listed as “210x USB to UART Bridge (COM#)” will be listed. The “#” is the COM port number assigned by your computer to interface with the instrument via USB virtual COM.
4. The serial (virtual COM) settings to use are:

**BAUDRATE: 57600**

**PARITY: NONE**





**DATA BITS: 8**

**STOP BIT: 1**

**FLOW CONTROL: NONE**





## ***GPIB Interface***

GPIB interface is available when the LAN/GPIB card is installed in the “S1” or “S2” slots in the rear panel. To setup the power supply for GPIB interface, follow the steps below:



1. Press **Menu**, then **1** to enter **SYSTEM SETTING**. Select **REMOTE** and press  or  until “**GPIB**” is displayed. Press  to save changes.
2. Select **GPIB ADDR** and use the numeric keypad to enter the GPIB address (1 – 30). Press  to save changes.

## ***Ethernet (LAN) Interface***

LAN interface is available when the LAN/GPIB card is installed in the “S1” or “S2” slots in the rear panel. To setup the power supply for LAN interface, follow the steps below:

1. Press **Menu**, then **1** to enter **SYSTEM SETTING**. Select **REMOTE** and press  or  until “**ETHERNET**” is displayed. Press  to save changes.
2. Select **IP CONFIG** and choose **STATIC**. Press  to save changes.

**STATIC** Allows you to configure a static IP address for the power supply.





3. If **STATIC** is selected, then select **IP ADDRESS** and use the numerical keypad to enter the static IP. After entering each group of 3 digits, press  to go to the next group. The cursor will automatically move to the next group. Do this until all 12 digits are entered. Be sure to press  one more time after entering the last 3 digits for the complete IP address entry to be saved.

## ***RS-232 and RS-485 Interface (Optional)***

Both RS-232 and RS-485 interface are supported by the power supply through an optional RS-232 or RS-485 interface card. Both of these card options must be properly installed before they can be used. See “1.7 Installing Optional Interface Cards” for details.

### **RS-232 Interface**

The setup for remote control via RS-232 interface is very similar to the same for USB virtual COM interface. To setup the power supply for RS-232 operation:

1. Press , then  to enter **SYSTEM SETTING**. Select **REMOTE** and press  or  until “**RS232**” is displayed. Press  to save changes.
2. The settings used for RS232 communication are:



**BAUDRATE: 57600**  
**PARITY: NONE**  
**DATA BITS: 8**  
**STOP BIT: 1**  
**FLOW CONTROL: NONE**

## RS-485 Interface

Multiple power supplies (up to 31) can be connected together in series and be controlled via USB (virtual COM) interface. Here is an illustration of how the setup will look like:

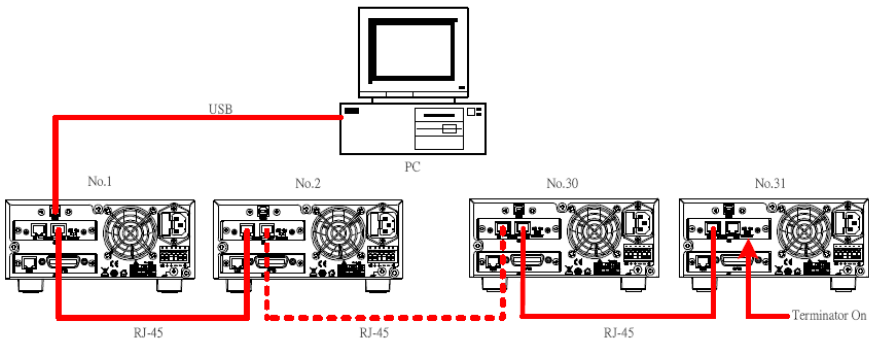

**Figure 15- RS-485 Setup to Control Multiple Supplies (USB)**

To setup and configure the power supplies, follow these steps:

### Requirements:





- Optional RS485 cards must be installed on each power supply
- For N number of power supplies, you will need N-1 number of Ethernet CAT5 straight (pin-to-pin) cables. (Example: To connect 5 power supplies, 4 cables are required)

---

**Note:** The cables are used to link the power supplies together. It is recommended to keep the cables as short as possible between each unit.

---

## **Communicate via USB**



1. Take one Ethernet CAT5 cable and connect one end to  labeled “**OUT**” on the RS485 interface card of the first power supply (the one that will be connected to the PC via USB cable).
2. Connect the other end to  labeled “**IN**” on the RS485 interface card of the second power supply.
3. To connect a third power supply, use another Ethernet CAT5 cable and connect one end to  labeled “**OUT**” on the second power supply. Connect the other end to  labeled “**IN**” on the interface card of the third power supply.
4. Repeat steps 2 and 3 for each subsequent power supplies added to the multi connection, making sure the connections follow the “**IN**” and “**OUT**” scheme as described.
5. After connecting to the “**IN**” port of the last power supply in the connection, if there are more than 10 units connected, set the physical switch labeled “**Terminator**” on the RS485 interface card of this last unit to “**On**”.

---

**Note:** The terminator switch should only be set to “**On**” for the last power supply in the chain. All other power supplies should have the terminator switch set to “**Off**”.

---

6. With a USB Type A to Type B cable, connect one end to the USB interface of the first power supply. Connect the other end to a PC to be used to control all the supplies. Refer to Figure 15 to verify your connections.

7. With the connections setup properly, on the first power supply, press **Menu** , then **1** to enter **SYSTEM SETTING**. Select **REMOTE** and verify that “**USB**” is selected. Press **Enter** to save changes.
8. Press **Esc** once to go back to the main menu and press **9** to enter **CHAIN SETTING**.
9. Select **CHAIN ON/OFF** and press  or  to set it to “**ON**”. Press **Enter** to save changes.
10. Select **CHAIN ADDRESS** and set it to “**1**”. Press **Enter** to save changes and then press **Esc** twice to exit the menu.
11. Repeat steps 7 thru 10 for each of the power supplies in the chain. However in step 10, set the **CHAIN ADDRESS** of each power supply to a different number. (i.e. Set to 1 for power supply #1, 2 for power supply #2, 3 for power supply #3, ...etc.) The address is used to reference the power supply during remote operation.
12. Refer to “4.2 Remote Commands” for the list of remote commands specific for RS485 communication.



### 3.3 Adjusting LCD Display, Key Lock, Key

# Sound

## ***LCD Backlight Timer***

The LCD backlight has a timer that can be set to dim its brightness within a set time from when the instrument is idle. To set this:

1. Press **Menu**, then **1** to enter **SYSTEM SETTING**. Select

**LCD BACKLIT**. Press  or  to change the backlight timer setting. Selectable options are:



<b>Options</b>	<b>Description</b>
ALWAYS ON	<b>Default</b> – Display never dims.
1 MINS OFF	Display dims after 1 minute
5 MINS OFF	Display dims after 5 minutes
10 MINS OFF	Display dims after 10 minutes
30 MINS OFF	Display dims after 30 minutes

2. Press  to save changes.





## ***Key Lock***

Users can manually lock the front panel keypad. To set this:

1. Press **Menu**, then **1** to enter **SYSTEM SETTING**. Select

**KEY LOCK**. Press  or  to change it. Selectable options are:



<b>Options</b>	<b>Description</b>
OFF	<b>Default</b>
ON	Lock keypad

2. Press  to save changes. Press  twice to exit the menu.
3. If **ON** is selected, all keys from the front panel, except for , will be locked. The **Lock** LED indicator will be lit.
4. To unlock, press  and the **Lock** LED indicator will turn off. The **KEY LOCK** option under **SYSTEM SETTING** category will automatically default back to **OFF**.

## ***Disabling Key Sound***

To disable the beep from key presses:

1. Press , then  to enter **SYSTEM SETTING**. Select

**BEEP**. Press  or  to change it. Selectable options are:

<b>Options</b>	<b>Description</b>
ON	<b>Default</b>
OFF	Disable key beep

2. Change it to **OFF**, and press  to save changes. All key presses will no longer beep.
3. To enable it again, set **BEEP** to **ON**.

## **3.4 Restore to Factory Default**

All instrument settings can be reset back to their factory default values by doing the following:

---

**WARNING:**

**Restoring the instrument to factory default will change all current instrument settings and parameters back to their default values.**

---

1. Press **Menu**, then **1** to enter **SYSTEM SETTING**. Select



**RECALL DEFAULT**. Press  or  to change it.

Selectable options are:

Options	Description
OFF	<b>Default</b>
ON	Resets instrument with factory default settings and parameters

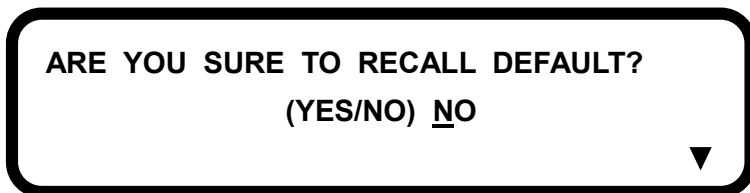
2. Change it to **ON**, and press . The following prompt will display:



3. To cancel this action, press  with **NO** marked by the cursor. To confirm resetting the instrument to factory default, press  to select **YES** and press .
4. After approximately 5 seconds, the instrument will automatically jump back to the normal display. All settings are now set back to their factory default values.

**Table 3 Factory Default Settings**

<b>REMOTE</b>	USB
<b>GPIB ADDR</b>	1
<b>KEY LOCK</b>	OFF
<b>IP CONFIG</b>	STATIC
<b>IP ADDRESS</b>	255.255.255.255
<b>BEEP</b>	ON
<b>LCD BACKLIT</b>	ALWAYS ON
<b>VOLT LIMIT MAX</b>	Max. rated voltage of model
<b>VOLT LIMIT MIN</b>	0.000V
<b>CURR LIMIT MAX</b>	Max. rated current of model
<b>CURR LIMIT MIN</b>	0.0005A
<b>V SLEWRATE</b>	7.000 V/ms
<b>I SLEWRATE</b>	0.6000 A/ms
<b>MEASURE AVERAGE TIME</b>	2
<b>LED MODE</b>	OFF
<b>OVP SETTING</b>	OFF, SET = Max. rated voltage of model
<b>OCP SETTING</b>	OFF, SET = Max. rated current of model
<b>TIMER FUNCTION</b>	OFF

## **3.5 Configure Voltage and Current Output**

### ***Voltage and Current Limit Settings***

The power supply has software voltage and current limit protection settings that can be configured to limit the settable range for output from front panel or remote operation. Follow the steps in this section to adjust these settings.

## Voltage Limit Set

1. Press **Menu**, then **2** to enter **OUTPUT SETTING**. Press **1** to select **VOLT LIMIT SETTING**.
2. **VOLT LIMIT MAX** should be selected. Use the keypad to enter the maximum voltage set limit and press **Enter** to save changes. The maximum voltage that can be set depends on the power supply's maximum output voltage.
3. **VOLT LIMIT MIN** is now selected. Again, use the keypad to enter the minimum voltage set limit and press **Enter** to save changes.
4. Press **Esc** once to return to previous menu items, or press three times to exit the menu when finished.

### Dual Channel Models

For models with dual channels, the display will look different, with **CH1** and **CH2** indicators on the left side of the display to indicate their respective **VOLT LIMIT MAX/MIN** parameters.

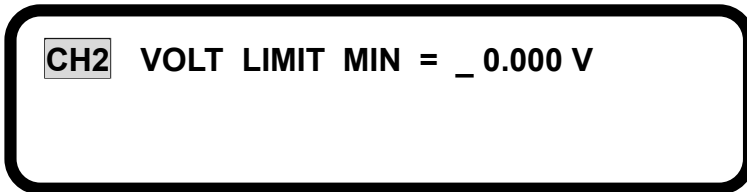
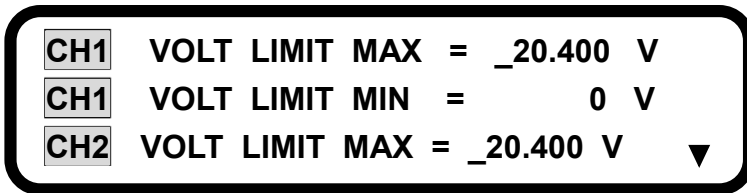



## Current Limit Set

1. Press **Menu**, then **2** to enter **OUTPUT SETTING**. Press **2** to select **CURR LIMIT SETTING**.
2. **CURR LIMIT MAX** should be selected. Use the keypad to enter the maximum current set limit and press **Enter** to save changes. The maximum current that can be set depends on the power supply's maximum output current.
3. **CURR LIMIT MIN** is now selected. Again, use the keypad to enter the minimum current set limit and press **Enter** to save changes.
4. Press **Esc** once to return to previous menu items, or press three times to exit the menu when finished.

## Dual Channel Models

For models with dual channels, the display will look different, with **CH1** and **CH2** indicators on the left side of the display to indicate their respective **CURR LIMIT MAX/MIN** parameters.

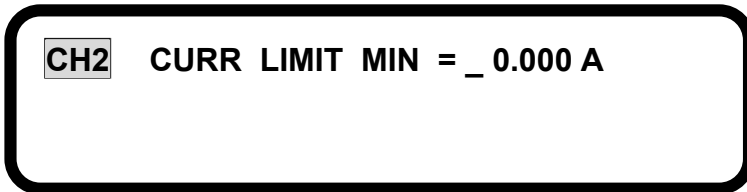
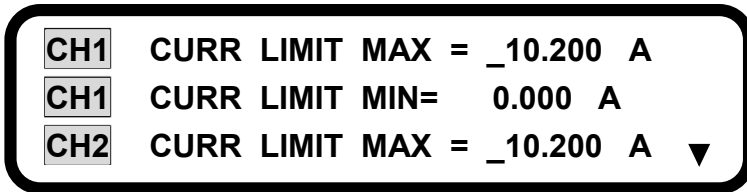



## Configure Voltage and Current Output

Voltage and current can be set and output from the front panel and the rear panel terminals. Refer to “3.7 Remote Sense” for setup instructions if remote sense will be used for voltage compensation at the output.

### Setting Voltage

Follow the steps below to set the output voltage:

1. For single channel models, skip to step 2 below. For dual channel models, from the main display press  or  to select the channel for setting voltage. The channel indicators **CH1** or **CH2** will flash to indicate the selected channel.
2. With the main display shown, press **Vset** use the numeric keypad to enter your set voltage. Then press . Below is an example screen for setting 5 V.



**SET = 5.000 V**  
**OFF 5.000 V 1.000 A**

For Dual Channel models:

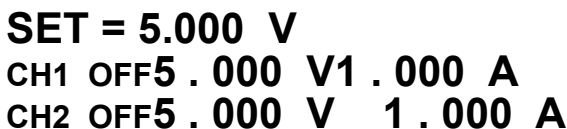

**SET = 5.000 V**  
**CH1 OFF 5.000 V 1.000 A**  
**CH2 OFF 5.000 V 1.000 A**

3. Models 9184 and 9185 do not have auto ranging available.  
The range must be selected manually and can be set as **HIGH** or **LOW** range.

9184: **HIGH** range – 200 V / 1 A

**LOW** range – 100 V / 2 A

9185: **HIGH** range – 600 V / 0.35 A

**LOW** range – 400 V / 0.5 A

To select **HIGH** range, press  from the normal display where **VOLT RANGE** is indicated.

OFF200 . 00 V 1 . 000 A  
VOLT RANGE = HIGH (▲ : H / ▼ : L)

To select **LOW** range, press  instead.

OFF100 . 00 V 2 . 000 A  
VOLT RANGE = LOW (▲ : H / ▼ : L)



---

**Note:** The voltage setting range is dependent on the unit's maximum voltage output specification as well as the voltage limits set from the system menu. Verify **VOLT LIMIT MAX** and **VOLT LIMIT MIN** settings if you are unable to set a voltage within the specifications of the power supply.

---

## Setting Current

Follow the steps below to set the output current:

1. For single channel models, skip to step 2 below. For dual channel models, from the main display press  or  to select the channel for setting current. The channel indicators **CH1** or **CH2** will flash to indicate the selected channel.
2. With the main display shown, press **iset** and use the numeric keypad to enter your set current. Then press **Enter**. Below is an example screen for setting 2 A.

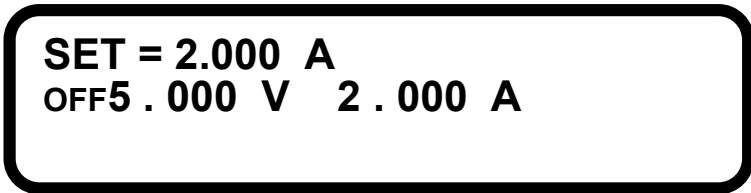

### For Dual Channel models:

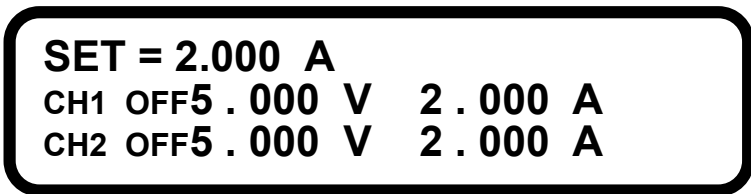

3. Models 9184 and 9185 do not have auto ranging available. The range must be selected manually and can be set as **HIGH** or **LOW** range.

9184: **HIGH** range – 200 V / 1 A

**LOW** range – 100 V / 2 A

9185: **HIGH** range – 600 V / 0.35 A

**LOW** range – 400 V / 0.5 A

To select **HIGH** range, press  from the normal display

To select **LOW** range, press  instead.

---

**Note:** The current setting range is dependent on the unit's maximum current output specification as well as the current limits set from the system menu. Verify **CURR LIMIT MAX** and **CURR LIMIT MIN** settings if you are unable to set a current within the specifications of the power supply.

---

## Enable/Disable Output

---

### WARNING:

Before connecting wires to the front or rear panel output terminals, output should remain **OFF** to avoid shocks and damage to the device under test (DUT), especially when setting the supply for high voltage output. For safety, load wires must have a wire gauge size large enough to prevent overheating when the power supply operates at maximum short circuit output current. It will also prevent large voltage drops from resistances in the wires.







---

The  button is used to enable or disable the supply output

from both the front panel and the rear panel output terminals. A green LED light next to the button will be lit when  is pressed to turn ON (enable), and the **OFF** annunciator will disappear from the display. This will reappear when output is OFF (disable) upon pressing  again, and the green LED light will disappear. For dual channel models,  and  are used in place of  as output ON/OFF for CH1 and CH2 respectively. Dual channel models can also be configured so that both channels' output states (ON or OFF) can be synchronized. See "3.6Dual Channel Configurations" under "Multi/Single Output Control" for setup instructions.

## Controlling Voltage/Current Output with Keys

When the output is ON (enabled), the voltage (CV mode) or current (CC mode) output can be controlled incrementally by key presses.

To do this, press  or  and a cursor will appear, highlighting the last digit of the measured voltage or current display. Use  or  to change and select the digit you want to change, and press  or  to increase or decrease that digit. The output voltage or current will change immediately as you change the digits. Press  at any time or allow the supply to idle for 10 seconds (without any key presses) to go back to the normal display.

CV5 . 000 V1 . 000 A

For Dual Channel models:

CH1CV5 . 000 V1 . 000 A  
CH2CV5 . 000 V1 . 000 A

---

**Note:**The voltage setting range is dependent on the unit's maximum voltage output specification as well as the voltage limits set from the system menu. Verify **VOLT LIMIT MAX** and **VOLT LIMIT MIN** settings if you are unable to set a voltage within the specifications of the power supply.

---

## ***Slew Rate Configuration***

Voltage and current slew rate of the output can be configured by doing the following:

1. Press **Menu**, then **2** to enter **OUTPUT SETTING**. Press **3** to select **VOLT SLEWRATE SETTING**. The following will be displayed:

V SLEWRATE = \_ 7.000 V / ms

For Dual Channel models:

CH1 V SLEWRATE = \_ 7.000 V / ms

CH2 V SLEWRATE = \_ 7.000 V / ms

2. Use the keypad to enter the voltage slew rate. (Refer to Table 4) Then press **Enter** to save the changes.
3. Press **Esc** once to return to the previous menu items, and press **4** to select **CURR SLEWRATE SETTING**. The following will be displayed:



I SLEWRATE = \_ 0.600 A / ms

For Dual Channel models:

CH1 I SLEWRATE = \_ 0.600 A / ms

CH2 I SLEWRATE = \_ 0.600 A / ms



- Use the keypad to enter the current slew rate, then press  to save changes.
- Press  once to return to previous menu items, or press three times to exit the menu when finished.



**Table 4- Voltage and Current Slew Rate Ranges**

<b>Model</b>	<b>V Slew Rate (V/ms)</b>	<b>I Slew Rate (A/ms)</b>
9171	0.001 – 2.500	0.001 – 1.250
9172	0.001 – 7.000	0.001 – 0.300
9173	0.001 – 2.500	0.001 – 1.250
9174	0.001 – 7.000	0.001 – 0.300
9181	0.001 – 4.500	0.001 – 1.000
9182	0.001 – 2.500	0.001 – 2.500
9183	0.001 – 7.000	0.001 – 0.600
9184	0.001 – 6.666	0.001 – 0.066
9185	0.001 – 15.00	0.001 – 0.0125





## ***Output Timer Function***

The power supply has a built-in output timer function that can be enabled to allow setting a time in which output is remained ON.

Follow the steps below to setup this function:

- Press , then  to select **TIMER FUNCTION**. The following screen will be displayed:







2. While the cursor is selecting **TIMER**, press  so that **ON** is selected, then press  to set and select **TIME**. This will be the time for which the output will remain ON.
3. Use the numeric keypad to enter the **Hr** (hour) for the output to remain ON. Press  to select **Min** (minute). Enter a value and press  again to select **Sec** (second).
4. The acceptable ranges are:  
**Hr: 0 – 999, Min: 0 – 59, Sec: 0 – 59**
5. Press  once to return to previous menu items, or press three times to exit the menu when finished.
6. Upon returning to the main display, it will show the following:

**TIMER = 000 : 00 : 00 Sec**  
**OFF10 . 000 V1 . 000 A**

**For Dual Channel models:**

**TIMER = 000 : 00 : 00 Sec**  
**CH1OFF10 . 000 V1 . 000 A**  
**CH2OFF10 . 000 V1 . 000 A**

7. Press  ( or  for dual channel models) to turn the output ON, and the **TIMER** on the display will start running. The  annunciator will display, and the output will remain ON until the configured time period (from step 3) ends.

---

**Note:**For dual channel models, the timer function will work only with both channels ON (enabled) simultaneously regardless of the **OUTPUT MODE** setting configured in **SYSTEM SETTING** menu. The internal timer is shared by both channels.

---

## ***Measurement Average Setting***

The averaging measurements used to display a reading can be adjusted by following the steps below:

1. Press **Menu**, then **2** to enter **OUTPUT SETTING**. Press **5** to select **MEASURE AVERAGE**. The following will display:

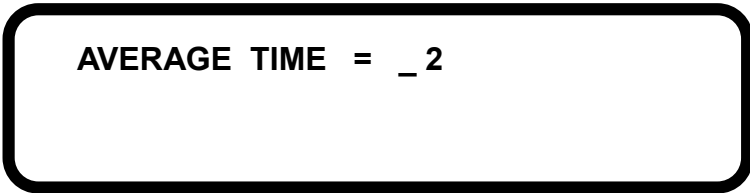

**AVERAGE TIME = \_ 2**

2. Use the numeric keypad to enter the number of measurements the instrument will average out prior to displaying the value. **Valid numbers are from 1 to 10.**
3. Press **Enter** to save changes, then press **Esc** three times to exit the menu.

## 3.6 Dual Channel Configurations

Features described in this section pertain to dual channel models 9173 and 9174 only. They are not available for all other models.

### *Multi/Single Output Control*



Dual channel outputs can be configured so that pressing the output buttons can turn ON (enable) or OFF (disable) both channels' outputs simultaneously.

---

**Note:** When multiple output control is setup, there will be a maximum of 3 ms delay between channel 1 and channel 2 when both channels change output from OFF (disable) state to ON (enable) state.

---

Follow the steps below to configure this setting:

1. Press **Menu** , then **1** to enter **SYSTEM SETTING**. Go down the list of settings and select **OUTPUT MODE**.
2. Press  to select **MULTI**. Press  to confirm the changes, and press **Esc** twice to exit the menu. If **SINGLE** is selected, output control of the two channels will not be simultaneous; their output states can be controlled independently.

## Series/Parallel Tracking Mode

Tracking mode can be enabled so that both channels can be synchronized, especially when connected together in series or parallel. To turn on tracking mode, follow the steps here:

1. Press **Menu**, then **1** to enter **SYSTEM SETTING**. Go down the list of settings and select **TRACKING MODE**.
2. Press  to select **ON**. Press **Enter** to confirm the changes, and press **Esc** twice to exit the menu. To disable it, select **OFF**.
3. The **TRK** annunciator will appear on the display to indicate tracking mode is enabled. Both channels are now synchronized.

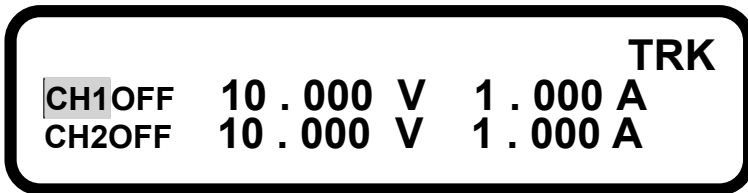

### 3.7 Remote Sense

Single channel models 9171, 9172, 9181, 9182, and 9183 have both front and rear panel remote sense terminals. Dual channel models 9173 and 9174, and high voltage single channel models 9184 and 9185 have rear panel remote sense terminals only. Remote sense can be used to compensate for voltage drops due to resistance from test leads connected to your device under test (DUT), thus providing more accurate output voltage. The power supply is initially setup to

local sense mode by default. Refer to the following sections for details of local and remote sense setup.

## Local Sense

All power supplies are setup with local sense by default. In local sense mode, shorting bars between the sense terminals and output terminals are connected on the front panel (if available) and rear panel outputs. Refer to Figure 16 below (Note: Some models do not have front panel sense terminals, indicated by +S and -S):

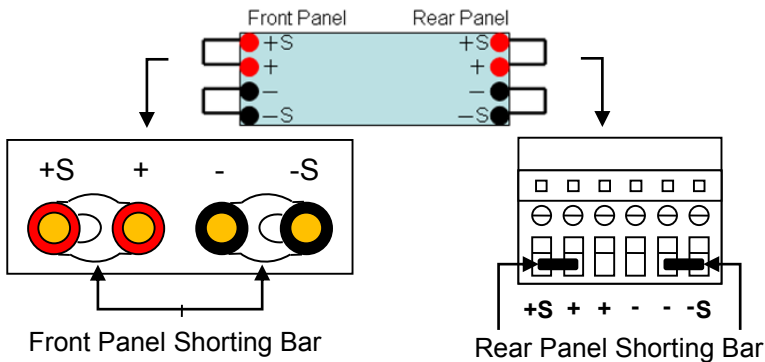

**Figure 16-Local Sense with Shorting Bar**

For front panel, +S and + terminals are shorted together, and -S and - terminals are shorted together with shorting bars. For rear panel, +S and + (next to +S) are shorted together, and -S and - (next to -S) are shorted together with small metal shorting bars.

---

**Note:**For calibration, local sense should be used.

---

## Remote Sense

To setup and use remote sense from the front panel (if available), both the front panel and rear panel shorting bars must be removed. The front +S and –S sense ports are then connected directly to the DUT, like Figure 17 below:

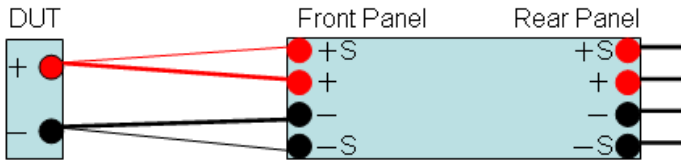

**Figure 17- Front Panel Remote Sense Setup**

To use remote sense from the rear panel, both front panel (if available) and rear panel shorting bars must also be removed. The rear +S and –S ports are connected directly to the DUT, like Figure 18 below:

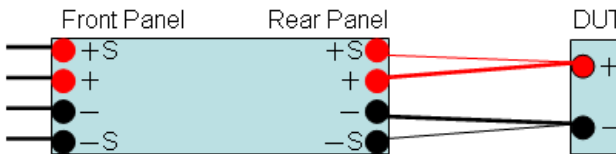

**Figure 18- Rear Panel Remote Sense Setup**

---

**WARNING:**

In remote sense where both the front and/or rear panel shorting bars are removed, never connect a device directly to the front (if applicable) and/or back +S and -S terminals only. Always connect the + and - terminals first, then connect the +S and -S terminals. Otherwise, the sense lines will burn out internally and cause damage to the supply.

---

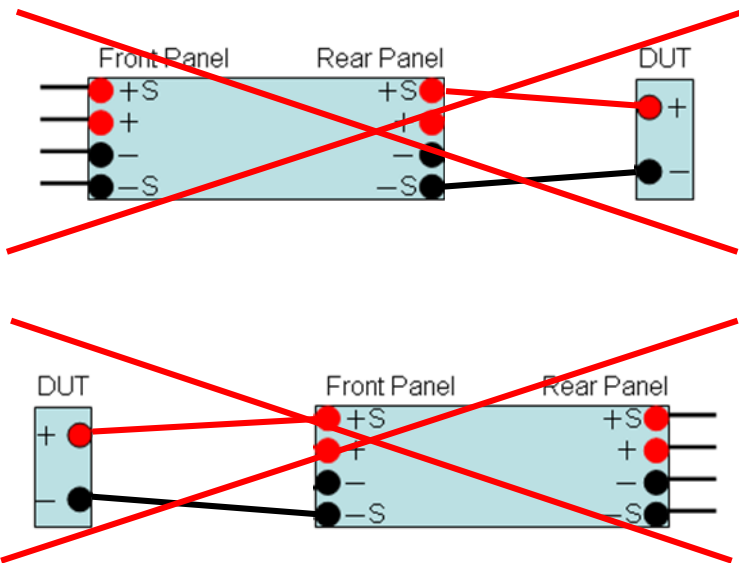
**DO NOT CONNECT LIKE BELOW:**

For operating with output current higher than 10 A, the connection is the same as Figure 18 above, with the addition of connecting the second pair of (+) and (-) terminals in the rear panel, like below:



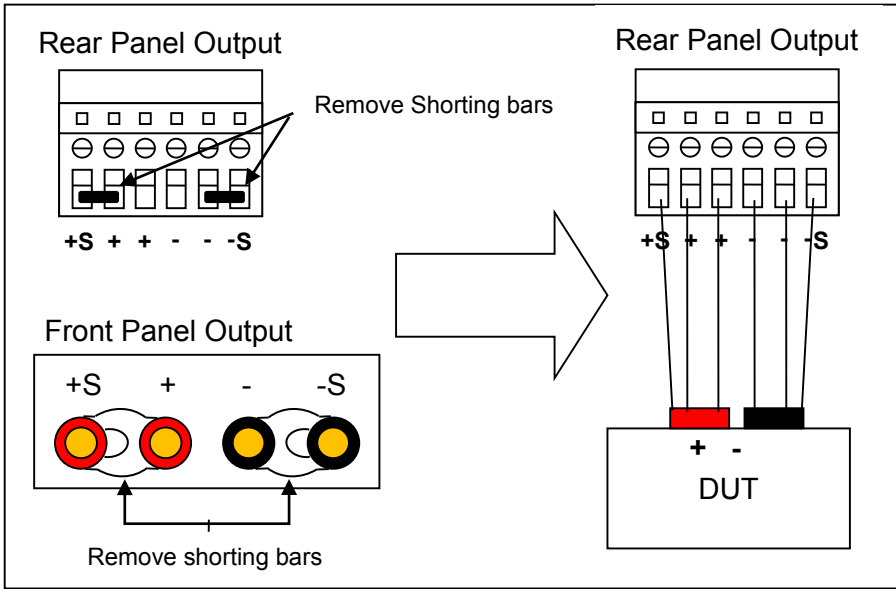

Figure 19- Remote Sense Setup for 10A or Higher Current Output Operation

**WARNING:**



**DO NOT** output 10A or more with only one pair of (+) and (-) terminals in the rear panel. Both (+) terminals and both (-) terminals must all be connected for applications requiring more than 10A output. Each terminal can only accept maximum of 10A. Exceeding this may damage the power supply.

## 3.8 LED and Low Current Test Modes

### *LED Mode*

All of these power supplies have LED mode, which enables them to function specifically for LED test applications. When this mode is ON (enabled), the power supply can operate in such a way as to minimize or almost eliminate the inrush current drawn by the LED load, which normally exists when the output switches from an OFF state to an ON state.

To enable LED mode, follow these steps:

1. Press **Menu**, then **2** to enter **OUTPUT SETTING**. Press **6** to select **LED MODE SETTING**.
2. Press  to select **ON**, then press  to confirm the changes. Press **Esc** twice to exit the menu. For dual channel models, both channels will have LED mode enabled.

**LED MODE = ON**

Consider the following example for 9184 with setup in Figure 20:

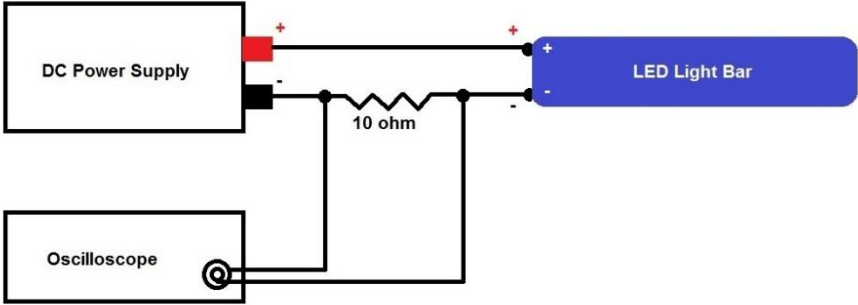

**Figure 20- LED Testing Example**

The 9184 supply output is initially OFF (disabled). The LED light bar is rated for 170 V. A 10 Ω resistor is placed in series with the LED light bar. The power supply current setting (ISET) is 20 mA. Using an oscilloscope to probe between the resistor to measure current, the power supply's output is then turned ON. The measured results are shown in Figure 21, which compares the measured results with and without LED mode ON (enabled):

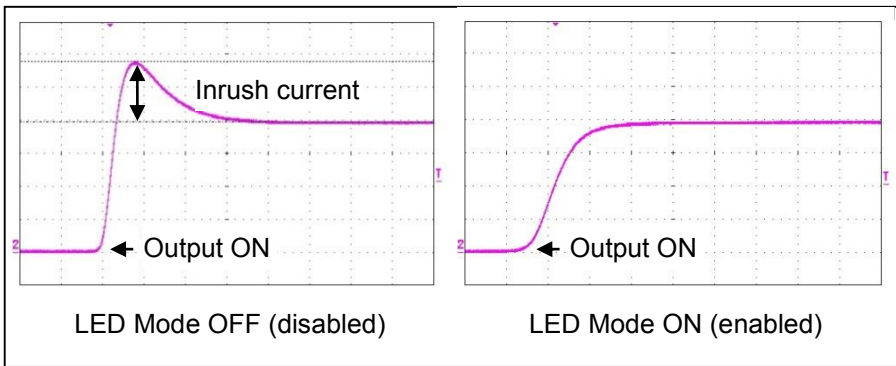

**Figure 21 - Inrush Current With and Without LED Mode Enabled**

With LED mode ON (enabled), the power supply can minimize or eliminate any inrush current from turning the output ON, which in turn will minimize damage or life of the LEDs under test.

---

**Note:**For LED mode to function correctly, the output must be turned OFF when connecting between the power supply and the LEDs under test. Turn ON the output after LED mode is enabled and all other settings are configured.

---

### **WARNING:**

**For models 9184 and 9185, Low Current MODE must be set to OFF when using LED mode. If both are ON, the supply may produce inrush current.**

---



## ***Low Current Mode***

**Available on models 9184 and 9185 only.**

Low current mode is a unique function that enables the power supply to minimize voltage rise times when operating with low current (< 1 A) output with a high voltage change.

To enable Low current mode, follow these steps:

1. Press **Menu** , then **2** to enter **OUTPUT SETTING**. Press **6** to select **Low Current MODE**.

2. Press  to select **ON**, then press  to confirm the changes. Press  twice to exit the menu.

**LED MODE = OFF**  
**Low Current MODE = ON**

Consider the following example screenshots measuring a voltage change from 0 V to 60 V with a load of 100 mA connected to the output.

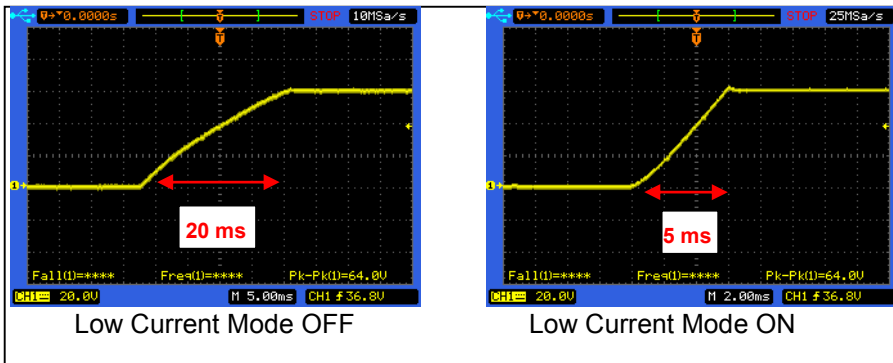

Figure 22 - Inrush Current With and Without Low Current Mode Enabled

When operating with low current output, enabling Low Current mode can reduce the voltage rise time upon a change in the voltage output.

## 3.9 Output Protection

### *Configure OVP*

Overvoltage protection (OVP) is available to limit the voltage output and to protect a connected DUT from an overvoltage condition.





When the power supply trips the OVP, a short beep will sound and the OVP (OVP1/OVP2 for dual channel models) LED indicator on the front panel will be lit. The green output light will also disappear and output will turn OFF (disable) immediately. To clear the OVP trip, press any key and the OVP (OVP1/OVP2 for dual channel models) LED indicator will turn OFF. To activate OVP, follow the steps below:

1. Press **Menu** , then **3** to enter **PROTECTION**, and press **1** to select **OVP SETTING**.

**OVP = ON      SET =      70.000 V**

#### For Dual Channel models:



**CH1 OVP = ON      SET =      70.000 V**  
**CH2 OVP = OFF      SET =      70.000 V**

2. Press  to select **ON**. Press  to confirm the changes, and use the numeric keypad to set the voltage limit for the protection to trip. Press  again to save changes. When the power supply voltage output reaches this limit, the OVP will trip.
3. Press  twice to exit the menu. To disable it, select **OFF**.

## ***Configure OCP***

Overcurrent protection (OCP) is available to limit the current output and to protect a connected DUT from an overcurrent condition.





When the power supply trips the OCP, a short beep will sound and the OCP (OCP1/OCP2 for dual channel models) LED indicator on the front panel will be lit. The green output light will also disappear and output will turn OFF (disable) immediately. To clear the OCP trip, press any key and the OCP (OCP1/OCP2 for dual channel models) LED indicator will turn OFF. To activate OCP, follow the steps below:

1. Press , then  to enter **PROTECTION**, and press  to select **OCP SETTING**.

**OCP = ON      SET =      10.000 A**

**For Dual Channel models:**

<b>CH1</b>	<b>OCP = ON</b>	<b>SET = 10.000 A</b>
<b>CH2</b>	<b>OCP = OFF</b>	<b>SET = 10.000 A</b>

2. Press  to select **ON**. Press  to confirm the changes, and use the numeric keypad to set the current limit for the protection to trip. Press  again to save changes. When the power supply current output reaches this limit, the OCP will trip.
3. Press  twice to exit the menu. To disable it, select **OFF**.

### **3.10 Save/Recall Output Settings**

The power supply has internal memory to store up to 10 settings, and each setting includes the set voltage (VSET) and set current (ISET) values.



## Save Output Settings

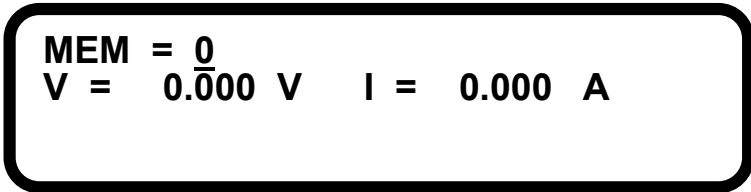

Follow these steps to save settings:

1. Press **Menu** , then **4** to enter **MEMORY SETTING**. The following screen will be displayed:



For Dual Channel models:



2. Press  or  or use the keypad to select the memory location to store settings into. Choose between 0 – 9.
3. Press **Enter** to set, and use the keypad to enter a value for voltage. Afterwards, press **Enter** and enter a value for current **Enter** once more and the voltage and current values will be stored into the selected memory location.
4. The cursor will then automatically move back to select **MEM**, and the location number will automatically increment to the next, except if number 9 (last memory location) was previously selected.

5. For dual channel models, repeat step 3 twice, once for CH1 and for CH2. Each memory location will store both channels' voltage and current settings.

## Recall Output Settings

To recall a saved setting:

1. Press **RCL** the screen will display as follows:

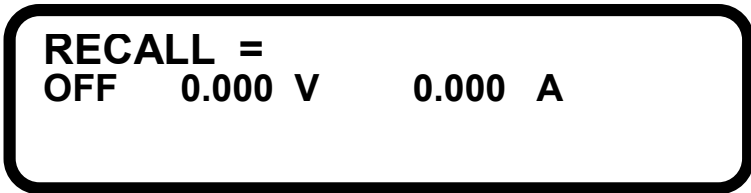

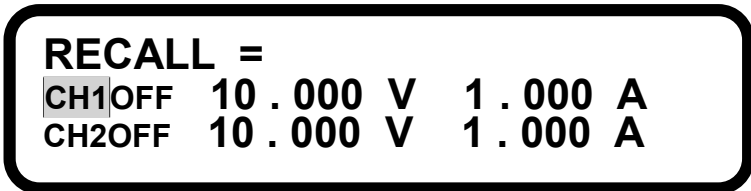

For Dual Channel models:



2. Use the keypad to enter the memory location that contains the voltage and current values to recall. The voltage and current settings will change immediately to the recalled settings.

## Configure Power-On State

The power supply can be powered up to a last known state, which can be useful in the case of power interruption. To configure this, follow the steps below:

1. Press **Menu**, then **1** to enter **SYSTEM SETTING**. Select **POWER ON STATE**. Press  or  to change it to **LAST** for setting the power on state to last known configuration. Select **OFF** to turn it off.
2. Press  to confirm the change.

### 3.11 Sequence Program Mode

Up to 10 (1 – 10) programmed sequences can be stored into the internal memory of the power supply and be executed from the front panel or via remote commands. A sequence consists of various steps of voltage and current values with a user defined time to hold at each step. This allows the user to change the voltage and current output of the power supply at different timings in a sequence. **The maximum number of steps per sequence is 150, and the minimum timing in between steps is 10 ms. For dual channel models, the programmed sequence will control both channels per every step. Programming a sequence for each channel independently is not supported.**

Sequences must be programmed into the memory via remote interface (i.e. USB, GPIB, Ethernet) before it can be executed from the front panel. See “4 Remote Operation” for details.

Assuming that sequences are already programmed into the internal memory, follow these steps to execute a program.

1. Press **Menu** , then **5** to enter **PROGRAM MODE**. The following screen will be displayed:



**PROGRAM NUMBER = 0**  
**PROGRAM OFF**

2. Use the keypad to select the program number where the sequence is stored. Valid number is 1 – 10. Press **Enter** to confirm the program.
3. Press **OUTPUT** (**CH1** or **CH2** for dual channel models) to enable the output and execute the programmed sequence. For dual channel models, both outputs will turn ON.
4. To disable the sequence at any time, press **OUTPUT** (**CH1** or **CH2** for dual channel models) again. This will also turn OFF the output. For dual channel models, both outputs will be OFF.

## 3.12 External Analog Control

The power supply output(s) can be controlled by external DC voltage sources (0 – 5 V or 0 – 10 V) or resistances (0 – 5kΩ). **The optional DIO/Analog Card must be installed for this function to be available.**

---

**Note:** The external control circuit uses a 12-bit D/A converter, thus resolution for voltage and current is limited to 10 mV and 10 mA respectively.

---

---

**WARNING:**

**The terminals for external analog control of voltage and current have no input protection. Therefore take caution when connecting to a DC source or a resistance. For voltage source control, do not input a voltage outside of the range -0.7 V to 5.7 V for the 0-5 V scale, or -0.7 V to 10.7 V for 0-10 V scale. This will damage the supply. For resistance control, do not connect with resistance greater than 5 k $\Omega$ . Doing so may damage the instrument and cause it to go out of calibration.**

---

---

**WARNING:**

**External analog control inputs do not have reverse polarity protection. Therefore, for external voltage control, do not connect to a live DC source until verifying that the positive side is connected properly to the (+) terminal and negative side to the (-) terminal for both current and voltage. Never short the (+) and (-) terminals together as it may damage the instrument.**

---

## Voltage Control

You can select the voltage control scale between 0 – 5 V or 0 – 10 V, with 5 V and 10 V setting the maximum voltage/current output respectively, and 0 V being the minimum voltage/current output, which is 0 V/0 A (The scale factor is linear to the full scale voltage/current output). With model 9172 (rated 35V/3A, 70V/1.5A) as an example, using the 0 – 10 V scale and applying 0 V input for **V**

will output 0 V. Applying 10 V input for **V** will output 35 V or 70 V depending on the range. Likewise, 10 V for **I** will set current to 3A or 1.5 A depending on the range. See the setup below:

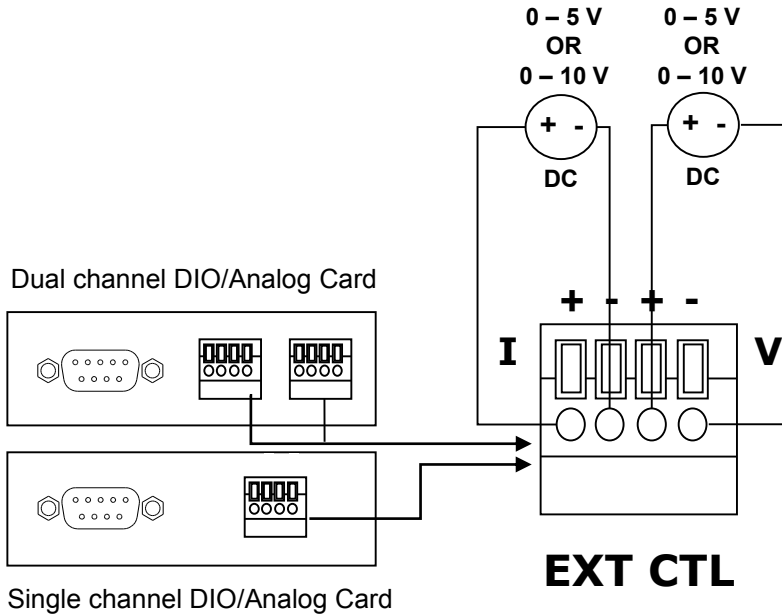

**Figure 23- External Voltage Control**

---

**Note:** Two separate DC voltage sources must be used for the setup. One for controlling voltage and one for current. Using one for either voltage or current will not operate correctly. If source is used for voltage, current setting will remain 0. If source is used for current, voltage setting will remain 0.

---

## Resistance Control

You can externally control the voltage/current output with variable resistances 0 – 5 k $\Omega$ . 5k $\Omega$  sets the maximum voltage/current output, and 0 k $\Omega$  will set the minimum voltage/current output, which is 0 V/0

A (The scale factor is linear to the full scale voltage/current output).

See the setup below:

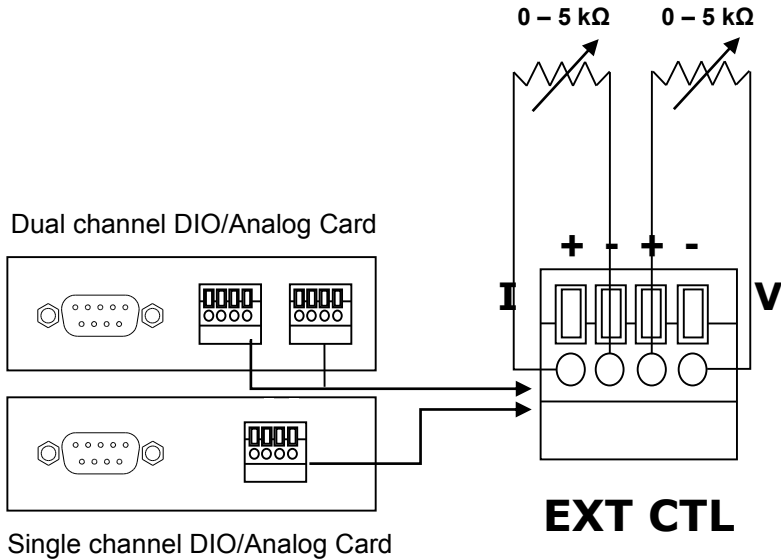





**Figure 24- External Resistance Control**

---

**Note:** Two separate variable resistances must be used for the setup. One for controlling voltage and one for current. Using one for either voltage or current will not operate correctly. If resistance is used for voltage, current setting will remain 0. If resistance is used for current, voltage setting will remain 0.

---

Follow the steps below to setup the supply for external analog control:

1. Press **Menu** , then **1** to enter **SYSTEM SETTING**.
2. Go down to **EXTERN CONTROL** (this option is only available with DIO/Analog Card installed) and press  or  to select between **OFF**, **VOLT**, or **RES**. Select **VOLT** for external voltage control or **RES** for external resistance control. Select **OFF** to disable external analog control.
3. Press **Enter** to save the change. If **VOLT** is selected in the previous step, go to **EXTERN LEVEL** setting right below **EXTERN CONTROL** and press  or  to select between **5V** or **10V**. Selecting **5V** means a 0 – 5V source will be used to control the full range of the voltage/current. Similarly, **10V** means a 0 – 10V source will be used.
4. Press **Enter** again to save the change, and press **Esc** twice to go to the main screen, which will look like the following below (Note that voltage and current resolution will be 10 mV and 10 mA for external analog control):



**For Dual Channel models:**





5. Press **OUTPUT** to turn the output ON (enabled), and output voltage and current will change as your external DC voltage sources or resistances change.

---

**Note:** When external analog control is enabled, all front panel keys are locked except for **Menu** and **OUTPUT** (**CH1** or **CH2** for dual channel models). Output voltage and current is locked to be controlled with the connected external voltage sources or resistances only. To return to normal control and display mode, follow the steps above to disable external analog control.

---

### 3.13 Digital I/O

**Digital I/O functions are supported with the DIO/Analog card installed.**

The instrument uses a DB-9 9-pin interface for digital I/O operations. A total of 9 pins are available, 8 of which can be configured as **INPUT** or **OUTPUT** and 1 for ground (GND) via remote commands (Refer to Table 5). The maximum voltage for input is **5 V**, and maximum voltage for output from the supply is also **5 V**.

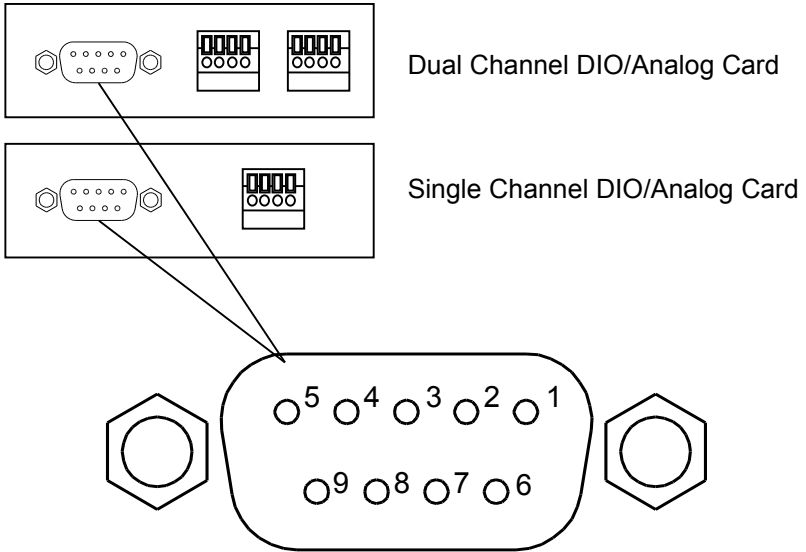

Figure 25- Digital I/O Interface

Below are the pin assignments for each of the 9 pins.

Table 5- Digital I/O Pin Assignment

Pin#	9	8	7	6	5	4	3	2	1
Type	I/O	I/O	I/O	I/O	GND	I/O	I/O	I/O	I/O
Binary Bit #	7	6	5	4	-	3	2	1	0
Decimal Representation	128	64	32	16		8	4	2	1
I/O – Can be set to either input or output. GND – Ground pin									

**WARNING:**

**Do not input more than 5 V to any of the digital I/O pins. Doing so may damage the instrument and void its warranty.**

## ***INPUT***

Digital input for representing logic high (1) is 5 V, and for logic low (0) is 0 V.

**Minimum voltage for logic high (1) must be at least 3.15 V.**

**Maximum voltage for logic low (0) must not exceed 1.35 V.**

To setup any of the 8 pins (except pin 5) as input pins, the remote command **GPIO:DIR** is used. All pins (except pin 5) are represented as 8-bits binary, according to Table 5 above. A “1” represents **OUTPUT**, and a “0” represents **INPUT**. When using the **GPIO:DIR** command, the decimal representation of the 8-bits binary is used.

For example, to set pins 7, 4, 2 and 1 as **INPUT** pins, their values must be set to **0**, and the rest **1**. Send:

### **GPIO:DIR 212**

**212** is used to represent **11010100** in binary. Only pins 7, 4, 2, and 1 have the value “0”, which represents **INPUT**.

Pin	9	8	7	6	5	4	3	2	1
	1	1	0	1	-	0	1	0	0

To check the status of the input pins to be either 5 V (1) or 0 V (0), use the **GPIO?** query command. It will return the decimal representation of the 8-bits binary that represents all the pins. The pins with bit value “1” have 5 V at the input, and “0” for 0 V at input.

For example, suppose all pins are set as **INPUT** pins, but only pin 2 and 1 have a 5 V logic high (1) signal, then only these two pins return “1” and the rest “0”. Sending **GPIO?** command will return: **3**. The complete 8-bit binary would be **00000011**.

Pin	9	8	7	6	5	4	3	2	1
	0	0	0	0	-	0	0	1	1

Note if there are output pins configured, those pins are ignored and will have the value “0”.

## ***OUTPUT***

To setup any of the 8 pins (except pin 5) as output pins, the remote command **GPIO:DIR** is used. All pins (except pin 5) are represented as 8-bits binary, according to Table 5 above. A “1” represents **OUTPUT**, and a “0” represents **INPUT**. When using the **GPIO:DIR** command, the decimal representation of the 8-bits binary is used.

For example, to set pins 8, 6, and 3 as **OUTPUT** pins, their values must be set to **1**, and the rest **0**. Send:

### **GPIO:DIR 84**

**84** is used to represent **01010100** in binary. Only pins 8, 6, and 3 have the value “1”, which represents **OUTPUT**.

Pin	9	8	7	6	5	4	3	2	1
	0	1	0	1	-	0	1	0	0

Digital output for representing logic high (1) is 5 V, and for logic low

(0) is 0 V. To set an output pin's logic level, use the **GPIO** remote command. Again, all pins (except pin 5) are represented as 8-bits binary, according to Table 5 above. When using the **GPIO** command, the decimal representation of the 8-bits binary is used.

Taking the example above with pins 8, 6, and 3 set as **OUTPUT** pins, if pins 8 and 3 are to be set with logic high (5 V) and pin 6 set with logic low (0 V), send the following command:

### GPIO 68

**68** is used to represent **01000100** in binary. Only pins 8 and 3 have the value “**1**” to represent logic high and output 5 V. Pin 6 has the value “**0**” to represent logic low and output 0 V. All other pins should be “**0**” as they are input pins and thus, are ignored.

Pin	9	8	7	6	5	4	3	2	1
	0	1	0	0	-	0	1	0	0

## 3.14 Display Errors

The following errors may be displayed under certain operating conditions. Their descriptions are shown in the table below.

Error Message	Description
INPUT RANGE ERROR!	The input value is out of the settable range of the power supply.
TURN OFF OUTPUT FIRST	Disable output first before accessing menu.

## 3.15 Connecting in Series and Parallel

Some of the models in the series are capable of connecting to another model of the same kind in series or in parallel to double the voltage output or current output respectively. While these are possible for some models, some models cannot be connected in such a way. Please see the below list of warnings pertaining to such connections.

### **WARNING:**

- **Do not connect multiple units of models 9184 or 9185 in series or in parallel. Due to their high voltage output design, these cannot be configured to increase voltage or current in a series connection or parallel connection setup respectively.**
- **Only connect multiples units in series or parallel of the same model. Do not mix models together. For example, you can connect two 9171 together, but not 9171 and 9172 together.**
- **Do not connect more than 2 units of models 9174 when series/parallel tracking is used.**
- **Do not connect more than 3 units of models 9172 and 9183.**
- **Never connect more than 4 units at a time in series or parallel.**
- **Total voltage output can never exceed maximum 240 V.**
- **Do not use rear output terminals when connecting multiple units in series or in parallel. Use front panel output terminals only.**
- **When increasing the total output current by connecting multiple units in parallel, be sure that the connecting wires have enough thickness to handle the amount of current. Otherwise, they may overheat and/or drop voltage levels significantly.**

# 4 Remote Operation

## 4.1 Interface Connection

### *USB (Virtual COM) & RS-232*

All models have a standard USB interface (virtual COM) that can be used for remote communication. Optionally, an RS232 interface card is available for remote control via RS-232 interface. Both USB (virtual COM) and RS-232 have the same serial settings listed below:

- BAUDRATE: 57600**
- PARITY: NONE**
- DATA BITS: 8**
- STOP BIT: 1**
- FLOW CONTROL: NONE**

For RS-232 connectivity, refer to the diagram below for pin out information:

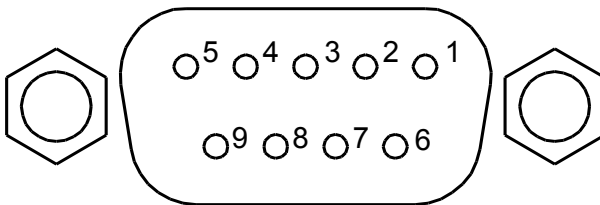

**Figure 26- RS-232 Interface**

**Table 6- RS-232 Pin Out**

<b>PIN</b>	<b>Description</b>
1	-
2	Transmit Data
3	Receive Data
4	-
5	GND
6	-
7	-
8	-
9	-

**A straight pin-to-pin DB9female to DB9male serial cable is required for using RS-232 interface. Do not use a null modem or crossover DB9 serial cable.**

## ***GPIB***

GPIB option is available when the supply is installed with the optional LAN/GPIB interface card. Each model can be configured with a GPIB address from 1 – 30. To communicate via GPIB, connect a GPIB cable to the GPIB interface of the LAN/GPIB interface card, as illustrated below.

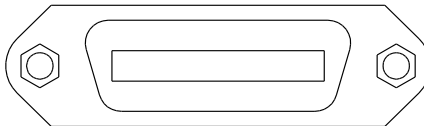

**Figure 27- GPIB Interface**



## ***Ethernet (LAN)***

Ethernet (LAN) option is available when the supply is installed with the optional LAN/GPIB interface card. There are three ways to control the power supply via LAN interface: Web server, Telnet connection, Socket connection.

### **Web Server**

There is an embedded web server GUI that can access the power supply via LAN interface using a java enabled web browser. The GUI provides a simple way of setting voltage and current, as well as monitoring the output, using a web browser from a computer connected to the same local area network as the power supply. To access this, do the following:

1. On the computer, open up a java-enabled web browser.
2. From the power supply menu, copy down the **IP ADDRESS** that you or the server configured and type in that address in the URL bar of your browser with **http://** prefix (i.e. **http://192.168.1.150** for IP Address 192.168.1.150)
3. If correctly configured, the following screen will be shown:

## Programmable Dual Range DC Power Supply

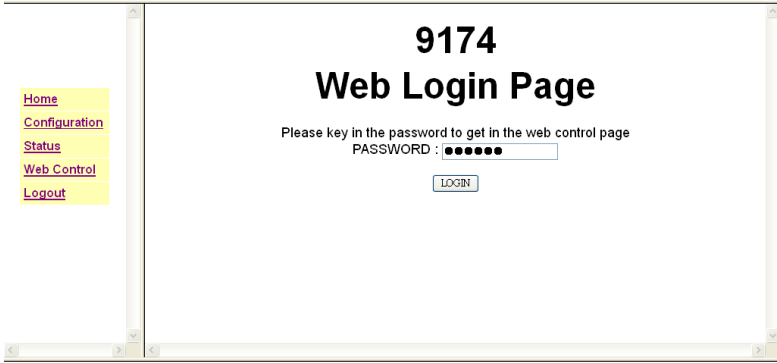

4. A password is required to login and access any of the menu items on the page.

DEFAULT ADMIN PASSWORD: **123456**

### Menu Items

This table describes each of the menu items available on the left frame of the web browser GUI.

**Table 7- Web Browser Menu Description**

<b>Home</b>	Provides general information of the power supply: <b>Model Number, Manufacturer, Short Description, MAC Address, IP Address, Firmware Version.</b>
<b>Configuration</b>	Allows users to configure: <b>OVP Setting, OCP Setting, LCD Backlight, *Change Password. *Be sure to remember the new password if changed because it cannot be override.</b>
<b>Status</b>	Shows last error or warning messages from the power supply. <b>It should normally be 0, which means no error(s).</b>
<b>Web Control</b>	Allows the user to manually send remote commands (see “4Remote Operation” for details) and control:

**Vset, Iset, Output state, Output On Timer.**

## Programmable Dual Range DC Power Supply

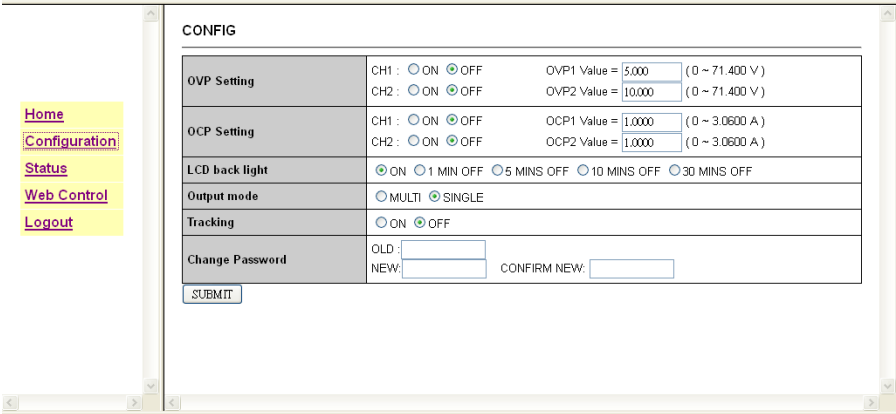

Copyright © 2012 B&K PRECISION. All Rights Reserved

**Figure 28 Configuration Page Screenshot**

## Programmable Dual Range DC Power Supply

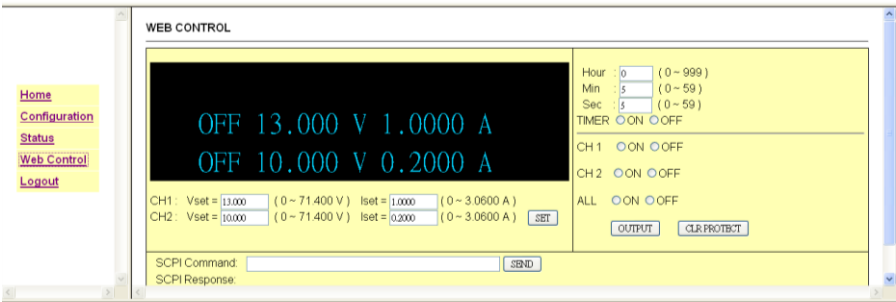

Copyright © 2012 B&K PRECISION. All Rights Reserved

**Figure 29 Web Control Page Screenshot**

## Telnet Connection

The power supply can be connected via Ethernet (LAN) interface using Telnet client with the following port:

Telnet Port: **5024**

### *Windows XP Users*

1. Open a command prompt window, which can be found by going to **Start > All Programs > Accessories > Command Prompt**. Alternatively, you can click on **Start**, select **Run...**, and type in **cmd** in the **Open:** input box. Click **OK** to open Command Prompt.
2. At the prompt, type in **Telnet<sp><device IP><sp>5024** where:  
**<sp>**is a space.  
**<device IP>**is the IP address you have configured for the power supply.(see “Ethernet (LAN) Interface” for details)  
**Example:** Telnet 192.168.1.150 5024
3. The following screen will be displayed, and users can enter remote commands at the prompt, such as **\*IDN?**.

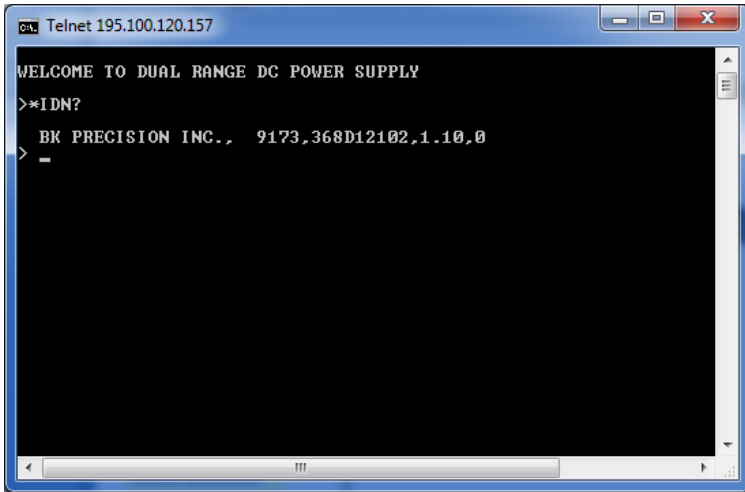

```
ca. Telnet 195.100.120.157
WELCOME TO DUAL RANGE DC POWER SUPPLY
>*IDN?
BK PRECISION INC., 9173,368D12102,1.10,0
> _
```

### ***Windows Vista/7 Users***

By default, Telnet client is not installed on the system. There are two ways to install it manually:

1. Open command prompt:
  - a. Select Windows **Start > All Programs > Accessories > Command Prompt**
  - b. Select Windows **Start** and type in **cmd** in the **Search programs and files** box and click on cmd.exe in the search list.

Then, type the following in the prompt (Note: there is only 1 space in between “pkgmgr” and “/iu”):

```
pkgmgr /iu:"TelnetClient"
```

This will install the Telnet Client, which should take about 20-30 seconds. When finished, close and re-open Command prompt and follow the same steps 2 and 3 for “Windows XP users” instructions above.

2. Alternatively, go to **Control Panel**, select **Programs**, and select **Turn Windows features on or off**. Wait until the list gets populated. Then, Click the box next to **Telnet Client**. When finished, follow steps 1a or 1b to open **Command Prompt** and follow the same steps 2 and 3 from “Windows XP users” instructions above.

### **Socket Connection**

Socket connection is available for communication via Ethernet (LAN) interface. The socket port is:

Socket Port: **5025**

Users can use this port to open a raw socket connection for sending remote commands.

## **4.2 Remote Commands**

The instrument supports some SCPI commands and some instrument specific commands. These commands enable a computer to remotely communicate and control the power supply over any of the supported remote interfaces: USB (virtual COM), RS-232, GPIB, LAN, and RS-485 (specific subset only).

## ***Parameter Definitions***

Unless otherwise noted, the following table of parameter definitions applies to all supported remote commands. Commands that have [ ] around them are optional. For example, [SOURCE] is not required for the SOURCE subsystem.

**Table 8- Parameter Definitions**

Parameter	Description
<Boolean>	“ON” or “1”, “OFF” or 0
<NR1>	Data format for integers. Zero, positive, and negative integer numeric values are valid data.
<NRf>	Data format for floating numeric representation. Zero, positive, and negative floating point numeric values are all valid data.
<LF>	Line feed character (0x0A) used for termination of a string
<CR>	Carriage return character (0x0D))used for termination of a string
<SP>	Space character

## ***Remote Commands***

All commands are terminated with both a <CR> and <LF>or just <LF>character. For example, to query the instrument’s ID, this command is sent:

**\*IDN?<CR><LF>**

**\*IDN?<LF>**

Commands sent without correct termination will return an error and/or will not have a response. **All commands listed in this**

**section do not have the termination character shown, but it is required for successful communication with the power supply.**All returned strings after a query command will terminate with both <CR> and <LF> characters. For example, sending **VOLT?**command may return:

**1.234<CR><LF>**

## **Common SCPI Commands**

The following commands are standard SCPI commands (1995) supported by the instrument.

### **\*IDN?**

**Description:** Query the instrument ID, which includes manufacturer name, model #, serial #, and firmware version all separated by commas. The last parameter is a "0" and is unused.

**Example:** \*IDN?

**Return String:** B&K PRECISION,9172,1234567,1.10,0

**Format:** <manufacturer>,<model>,<serial number>,<firmware version>,0

### **\*CLS**

**Description:** Clears status and errors

**Example:** \*CLS

### **\*RST**

**Description:** Resets the power supply to its power on state.

**Example:** \*RST



## **\*SAV**

**Description:** Saves power supply settings into a memory location

**Syntax:** \*SAV<SP><location>

<location> - Memory location number to save settings into. 0 – 9 are valid numbers.

**Example:** \*SAV 2

Saves instrument settings into memory location 2.

## **\*RCL**

**Description:** Recalls power supply settings

**Syntax:** \*RCL<SP><location>

<location> - Memory location number to recall settings from. 0 – 9 are valid numbers.

**Example:** \*RCL 3

Recalls instrument settings from memory location 3.

## **SCPI Command Subsystem**

The following list of commands under each subsystem is supported by the power supply. Some of them cannot be used without optional interface cards installed, such as the GPIO subsystem. See the notes under the command (if available) for details.

### **GPIO Subsystem**

#### **GPIO**

**:DIRection**

### **Measure Subsystem**

#### **MEASure**

**:CURRent?**

**:CURR2?**

**:VOLTage?**

**:VOLT2?**

### **Memory Subsystem**

#### **MEMory**

**:VSET**

**:VSET2**

**:ISET**

**:ISET2**  
**:SAV**

### Output Subsystem

#### OUTput

**:ALL**  
**:LIMit**  
    **:VOLTage**  
    **:VOLT2**  
    **:CURRent**  
    **:CURR2**  
**:MAX**  
    **:VOLTage**  
    **:VOLT2**  
    **:CURRent**  
    **:CURR2**  
**:MIN**  
    **:VOLTage**  
    **:VOLT2**  
    **:CURRent**  
    **:CURR2**  
**:SR**  
    **:VOLTage**  
    **:VOLT2**  
    **:CURRent**  
    **:CURR2**  
**:STATE?**  
**:PROTection**  
    **:CLEar**

### Channel 2 Output Subsystem (dual channel models only)

#### OUT2

**:STATE?**

### Program Subsystem

#### PROGram

**:CLEar**  
    **:ALL**  
**:NEXT**  
**:REPeat**  
**:RUN**  
**:SAV**  
**:STEP**  
    **:CURRent**  
    **:CURR2**  
    **:ONTime**

:VOLTage  
:VOLT2  
:TOTAL

### Protection Subsystem

#### PROTection

:CLEAr  
:OCP  
:LEVel  
:OCP2  
:LEVel  
:OVP  
:LEVel  
:OVP2  
:LEVel

### Source Subsystem

#### [SOURce]

:CURRent  
:PROTection  
:LEVel  
:CURR2  
:PROTection  
:LEVel  
:VOLTage  
:PROTection  
:LEVel  
:RANGe  
:VOLT2  
:PROTection  
:LEVel

### System Subsystem

#### SYStem

:AVERage  
:BEEP  
:ERRor?  
:EXTernal  
:LEVel  
:GPIB  
:ADDRess  
:IP  
:ADDRess  
:CONFIg  
:KEY  
:LOCK  
:LCD

:BL  
 :LED  
 :LOW  
 :CURR  
 :OUTput  
 :MODE  
 :RECall  
 :DEFault  
 :REMote  
 :SERies?  
 :TRACK

### Timer Subsystem

#### TIMER

:HOUR  
 :MINute  
 :SECond

## *GPIOSubsystem*

---

**Note:**The optional Analog/DIO interface card must be installed to use all GPIO commands.

---

**Table 9- Digital I/O Representation**

Pin#	9	8	7	6	5	4	3	2	1
Type	I/O	I/O	I/O	I/O	GND	I/O	I/O	I/O	I/O
Binary Bit #	7	6	5	4	-	3	2	1	0
Decimal Representation	128	64	32	16		8	4	2	1

I/O – Can be set to either input or output.  
 GND – Ground pin

## GPIO

- Description:** Configures digital I/O pins level to high (1) 5V or low (0) 0V for output pins. Nothing happens if the pin is an input.
- Syntax:** **GPIO<SP><decimal>**  
**<decimal>** - Decimal representation of the binary value representing the GPIO pins. 0 – 255 are valid.
- Example:** **GPIO 46**  
Sets pins 7, 4, 3, and 2 to logic high(1) 5 V output if these pins are configured as output pins using GPIO:DIRrection command (See “Table 9” to convert the binary representation). Refer to section “3.13Digital I/O” for more details.

## GPIO?

- Description:** Queries the voltage levels 1 (5 V) or 0 (0 V) of digital I/O input pins. Output pins return 0.
- Query:** **GPIO?**
- Return String:** **130**  
Pins 9 and 2 have 5 V input if these pins are configured as input pins using GPIO:DIRrection command (See “Table 9” to convert the binary representation). Refer to section “3.13Digital I/O” for more details.
- Format:** **<NR1>**

## GPIO:DIRrection

- Description:** Configures the digital I/O pins as inputs or outputs.
- Syntax:** **GPIO<SP><decimal>**  
**<decimal>** - Decimal representation of the binary value representing the GPIO pins. 0 – 255 are valid. Binary value of 1 is output and 0 is input.
- Example:** **GPIO:DIR 82**  
Sets pins 8, 6, and 2 as outputs and the rest as inputs (See “Table 9” to convert the binary representation). Refer to section “3.13Digital I/O” for more details.

## GPIO:DIRrection?

- Description:** Queries the digital I/O pins as outputs or

inputs.Binary value of 1 is output and 0 is input.  
**Query:** **GPIO:DIR?**  
**Return String:** **237**  
Pins 9, 8, 7, 4, 3, and 1 are outputs and the rest are inputs. (See “Table 9” to convert the binary representation). Refer to section “3.13Digital I/O” for more details.  
**Format:** <NR1>

## ***Measure Subsystem***

### **MEASure:CURRent?**

**Description:** Queries the measured current value  
**Query:** **MEAS:CURR?**  
**MEASure:CURRent?**  
**Return String:** **1.234**  
The measured current is 1.234 A.  
**Format:** <NRf>

### **MEASure:CURR2?**

**Note:** For dual channel models only.  
**Description:** Queries the measured current value of channel 2  
**Query:** **MEAS:CURR2?**  
**Return String:** **1.234**  
The measured current is 1.234 A.  
**Format:** <NRf>

### **MEASure:VOLTage?**

**Description:** Queries the measured voltage value.  
**Query:** **MEAS:VOLT?**  
**MEASure:VOLT?**  
**Return String:** **1.234**  
The measured voltage is 1.234 V.  
**Format:** <NRf>

### **MEASure:CURR2?**

**Note:** For dual channel models only.  
**Description:** Queries the measured voltage value of channel 2

**Query:** MEAS:VOLT2?  
**Return String:** 1.234  
The measured current is 1.234 V.  
**Format:** <NRf>

## ***Memory Subsystem***

### **MEMory**

**Description:** Selects the memory location/Returns the selected memory location.  
**Syntax:** **MEMory<SP><decimal>**  
<decimal> - Memory location. 0 – 9 are valid.  
**Example:** **MEM 2**  
Selects memory location 2.  
**Query:** **MEM?**  
**Return String:** 8  
Currently selected memory location is 8.  
**Format:** <NR1>

### **MEMory:VSET**

**Description:** Configures/Queries the voltage value to store at the selected memory location (use “MEM” command to select memory location first)  
**Syntax:** **MEMory:VSET<SP><decimal>**  
<decimal> - Voltage value. 0 – max. rated voltage value are valid.  
**Example:** **MEM:VSET 4.132**  
Sets 4.132 V as voltage for the selected memory location.  
**Query:** **MEM:VSET?**  
**Return String:** 4.132  
Voltage is currently set to 4.132 V in the selected memory location.  
**Format:** <NRf>

### **MEMory:VSET2**

**Note:** For dual channel models only.  
**Description:** Configures/Queries the second channel voltage value to store at the selected memory location (use “MEM”

**Syntax:** command to select memory location first)  
**MEMory:VSET2<SP><decimal>**  
**<decimal>** - Voltage value. 0 – max. rated voltage value are valid.

**Example:** **MEM:VSET2 4.132**  
Sets 4.132 V as voltage for the selected memory location.

**Query:** **MEM:VSET2?**

**Return String:** 4.132  
Voltage is currently set to 4.132 V in the selected memory location for channel 2.

**Format:** <NRf>

## **MEMory:ISSET**

**Description:** Configures/Queries the current value to store at the selected memory location (use “MEM” command to select memory location first)

**Syntax:** **MEMory:ISSET<SP><decimal>**  
**<decimal>** - Current value. 0 – max. rated current value are valid.

**Example:** **MEM:ISSET 2.159**  
Sets 2.159 A as current for the selected memory location.

**Query:** **MEM:ISSET?**

**Return String:** 2.159  
Current is currently set to 2.159 A in the selected memory location.

**Format:** <NRf>

## **MEMory:ISSET2**

**Note:** For dual channel models only.

**Description:** Configures/Queries the second channel current value to store at the selected memory location (use “MEM” command to select memory location first)

**Syntax:** **MEMory:ISSET2<SP><decimal>**  
**<decimal>** - Current value. 0 – max. rated current value are valid.

**Example:** **MEM:ISSET2 2.159**  
Sets 2.159 A as current for the selected memory location.

**Query:** **MEM:ISSET2?**

**Return String:** 2.159



Current is currently set to 2.159 A in the selected memory location for channel 2.

**Format:** <NRf>

## **MEMory:SAV**

**Description:** Saves the configured voltage and current (using MEM:VSET and MEM:ISET commands) values into the selected memory location (using MEM command).

**Syntax:** **MEMory:SAV**

**Example:** **MEM:SAV**

## **Output Subsystem**

### **OUTput**

**Description:** Configure/Query the state of the output.

**Syntax:** **OUTput<SP><Boolean>**

**OUTput?**

**Example:** **OUT 1**

**OUT ON**

Enables the output. For dual channel models, it enables output on channel 1.

**Query:** **OUT?**

**Return String:** ON

**Format:** ON or OFF

### **OUTput:ALL**

**Note:** For dual channel models only.

**Description:** Enables/Disables all channel output. This will override the **OUTPUT MODE** settings in the **SYSTEM SETTINGS** menu.

**Syntax:** **OUTput:ALL<SP><Boolean>**

**Example:** **OUT:ALL 1**

Enables both channels' outputs.

### **OUTput:LIMit:VOLTage**

**Description:** Configures/Queries the voltage maximum limit. For

dual channel models, this will configure voltage limit for channel 1.

**Syntax:** **OUTput:LIMit:VOLTage<SP><voltage>**  
**OUTput:LIMit:VOLTage?**  
**<voltage>** - Voltage value. 0 – max. rated voltage value are valid.

**Example:** **OUT:LIM:VOLT 70.123**  
Sets the voltage maximum limit to 70.123 V.

**Query:** **OUT:LIM:VOLT?**

**Return String:** 70.123

**Format:** <NRf>

## **OUTput:LIMit:VOLT2**

**Note:** For dual channel models only.

**Description:** Configures/Queries the voltage maximum limit for channel 2.

**Syntax:** **OUTput:LIMit:VOLT2<SP><voltage>**  
**OUTput:LIMit:VOLT2?**  
**<voltage>** - Voltage value. 0 – max. rated voltage value are valid.

**Example:** **OUT:LIM:VOLT2 70.123**  
Sets the voltage maximum limit to 70.123 V for channel 2.

**Query:** **OUT:LIM:VOLT2?**

**Return String:** 70.123

**Format:** <NRf>

## **OUTput:LIMit:CURREnt**

**Description:** Configures/Queries the current maximum limit. For dual channel models, this will configure current limit for channel 1.

**Syntax:** **OUTput:LIMit:CURREnt<SP><current>**  
**OUTput:LIMit:CURREnt?**  
**<current>** - Current value. 0 – max. rated current value are valid.

**Example:** **OUT:LIM:CURR 3.456**  
Sets the current maximum limit to 3.456 A.

**Query:** **OUT:LIM:CURR?**

**Return String:** 3.456

**Format:** <NRf>

## **OUTput:LIMit:CURR2**

**Note:** For dual channel models only.  
**Description:** Configures/Queries the current maximum limit for channel 2.  
**Syntax:** **OUTput:LIMit:CURR2<SP><current>**  
**OUTput:LIMit:CURR2?**  
**<current>** - Current value. 0 – max. rated current value are valid.  
**Example:** **OUT:LIM:CURR 3.456**  
Sets the current maximum limit to 3.456 A.  
**Query:** **OUT:LIM:CURR?**  
**Return String:** 3.456  
**Format:** <NRf>

## **OUTput:MAX:VOLTage**

**Note:** See **OUTput:LIMit:VOLTage** command.

## **OUTput:MAX:VOLT2**

**Note:** See **OUTput:LIMit:VOLT2** command.

## **OUTput:MAX:CURRent**

**Note:** See **OUTput:LIMit:CURRent** command.

## **OUTput:MAX:CURR2**

**Note:** See **OUTput:LIMit:CURR2** command.

## **OUTput:MIN:VOLTage**

**Description:** Configures/Queries the voltage minimum limit. For dual channel models, this will configure voltage limit for channel 1.  
**Syntax:** **OUTput:MIN:VOLTage<SP><voltage>**  
**OUTput:MIN:VOLTage?**  
**<voltage>** - Voltage value. Less than max. voltage set limit  
**Example:** **OUT:MIN:VOLT 0**  
Sets the voltage minimum limit to 0 V.

**Query:** **OUT:MIN:VOLT?**  
**Return String:** 0  
**Format:** <NRf>

### **OUTput:MIN:VOLT2**

**Note:** For dual channel models only.  
**Description:** Configures/Queries the voltage minimum limit for channel 2.

**Syntax:** **OUTput:MIN:VOLT2<SP><voltage>**  
**OUTput:MIN:VOLT2?**  
**<voltage>** - Voltage value. Less than max. voltage set limit value are valid.

**Example:** **OUT:MIN:VOLT2 0**  
Sets the voltage set minimum limit to 0 V for channel 2.

**Query:** **OUT:MIN:VOLT2?**  
**Return String:** 0  
**Format:** <NRf>

### **OUTput:MIN:CURRENT**

**Description:** Configures/Queries the current minimum limit. For dual channel models, this will configure current limit for channel 1.

**Syntax:** **OUTput:MIN:CURRENT<SP><current>**  
**OUTput:MIN:CURRENT?**  
**<current>** - Current value. Less than max. current limit value are valid.

**Example:** **OUT:MIN:CURRE 0**  
Sets the current minimum limit to 0 A.

**Query:** **OUT:MIN:CURRE?**  
**Return String:** 0  
**Format:** <NRf>

### **OUTput:MIN:CURRE2**

**Note:** For dual channel models only.  
**Description:** Configures/Queries the current minimum limit for channel 2.

**Syntax:** **OUTput:MIN:CURRE2<SP><current>**  
**OUTput:MIN:CURRE2?**  
**<current>** - Current value. Less than max. current limit value are valid.

**Example:** **OUT:MIN:CURRE2 0**

**Query:** Sets the current minimum limit to 0 A.  
**Return String:** **OUT:MIN:CURRE2?**  
**Format:** 0  
<NRf>

### **OUTput:SR:VOLTage**

**Description:** Configures/Queries the voltage slew rate in unit of V/ms. For dual channel models, this will configure the slew rate for channel 1.

**Syntax:** **OUTput:SR:VOLTage<SP><voltage>**  
**OUTput:SR:VOLTage?**

**<voltage>** - Voltage value. 0 – max. voltage slew rate value. See “Slew Rate Configuration” in section 3.5.

**Example:** **OUT:SR:VOLT 7.000**  
Sets the voltage slew rate to 7.000 V/ms

**Query:** **OUT:SR:VOLT?**  
**Return String:** 7.000  
**Format:** <NRf>

### **OUTput:SR:VOLT2**

**Note:** For dual channel models only.  
**Description:** Configures/Queries the voltage slew rate for channel 2.

**Syntax:** **OUTput:SR:VOLT2<SP><voltage>**  
**OUTput:SR:VOLT2?**

**<voltage>** - Voltage value. 0 – max. voltage slew rate value. See “Slew Rate Configuration” in section 3.5.

**Example:** **OUT:SR:VOLT2 7.000**  
Sets the voltage slew rate to 7.000 V/ms

**Query:** **OUT:SR:VOLT2?**  
**Return String:** 7.000  
**Format:** <NRf>

### **OUTput:SR:CURREnt**

**Description:** Configures/Queries the current slew rate in unit of

A/ms. For dual channel models, this will configure the slew rate for channel 1.

**Syntax:** **OUTput:SR:CURRENT<SP><current>**  
**OUTput:SR:CURRENT?**  
**<current>** - Current value. 0 – max. current slew rate value. See “Slew Rate Configuration” in section 3.5.

**Example:** **OUT:SR:CURR 1.000**  
Sets the current slew rate to 1.000 A/ms.

**Query:** **OUT:SR:CURR?**

**Return String:** 1.000

**Format:** <NRf>

## **OUTput:SR:CURR2**

**Note:** For dual channel models only.

**Description:** Configures/Queries the current slew rate for channel 2.

**Syntax:** **OUTput:SR:CURR2<SP><current>**  
**OUTput:SR:CURR2?**  
**<current>** - Current value. 0 – max. current slew rate value. See “Slew Rate Configuration” in section 3.5.

**Example:** **OUT:SR:CURR2 1.000**  
Sets the current slew rate to 1.000 A/ms.

**Query:** **OUT:SR:CURR2?**

**Return String:** 1.000

**Format:** <NRf>

## **OUTput:STATE?**

**Description:** Queries the output mode. For dual channel models, this will query for channel 1.

**Syntax:** **OUTput:STATE?**

**Query:** **OUT:STAT?**

**Return String:** CV

**Format:** CV or CC

## **OUT2 Subsystem**

The commands in this subsystem are for dual channel models only.

## **OUT2**

**Description:** Configure/Query the state of the output for channel 2.

**Syntax:** OUT2<SP><Boolean>  
**OUT2?**  
**Example:** OUT2 1  
**OUT2 ON**  
 Enables the output for channel 2.  
**Query:** OUT2?  
**Return String:** ON  
**Format:** ON or OFF

### **OUT2:STATE?**

**Description:** Queries the output mode for channel 2.  
**Syntax:** OUT2:STATE?  
**Query:** OUT2:STAT?  
**Return String:** CV  
**Format:** CV or CC

## ***Program Subsystem***

The commands in this subsystem are for the program sequence function. Examples on how to use these commands to create sequences can be found in “4.3Sequence Programming”.

### **PROG**

**Description:** Selects the program location/Returns the selected program location for storing programming sequence.  
**Syntax:** PROG<SP><decimal>  
 <decimal> - Program location. 1 – 10 are valid.  
**Example:** PROG 2  
 Selects program location 2.  
**Query:** PROG?  
**Return String:** 5  
 Currently selected program location is 5.  
**Format:** <NR1>

### **PROG:CLEAR**

**Description:** Clears all programmed sequences stored in the selected program location (Select using PROG

**Syntax:** command)  
**PROGRAM:CLEAr**  
**Example:** **PROG:CLE**  
Clears the programmed sequence at the selected program location.

### **PROG:CLEAr:ALL**

**Description:** Clears all programmed sequences stored in all 10 program locations.  
**Syntax:** **PROG:CLEAr:ALL**  
**Example:** **PROG:CLE:ALL**  
Clears all the programmed sequences in all 10 program locations.

### **PROG:NEXT**

**Description:** Configures/Queries the next program location's sequence to run.  
**Syntax:** **PROG:NEXT<SP><location>**  
**PROG:NEXT?**  
<location> - 1 – 10 are valid program locations. Use 0 to end if no further sequences will be run after the current sequence.  
**Example:** **PROG:NEXT 5**  
Runs the set of sequences in program location 5 after the current sequence is finished.  
**Query:** **PROG:NEXT?**  
**Return String:** 3  
Currently configured to run sequence in program location 3 after current sequence ends.  
**Format:** <NR1>

### **PROG:REPeat**

**Description:** Configures/Queries the number of times to repeat the selected programmed sequence.  
**Syntax:** **PROG:REPeat<SP><number>**  
**PROG:REPeat?**  
<number> - 1 – 50000 (max.)  
**Example:** **PROG:REP 10**  
Runs the set of sequences in the selected program



location 10 times.  
**Query:** **PROG:REP?**  
**Return String:** 300  
Currently set to repeat the sequence 300 times.  
**Format:** <NR1>

## **PROG:RUN**

**Description:** Configure/Query the state of the program.  
**Syntax:** **PROG:RUN<SP><Boolean>**  
**PROG:RUN?**  
**Example:** **PROG 1**  
**PROG ON**  
Enables the programmed sequence to start.  
**Query:** **PROG:RUN?**  
**Return String:** OFF  
Currently the selected program sequence is not running.  
**Format:** ON or OFF

## **PROG:SAV**

**Description:** Saves the programmed sequence into the selected memory location (Select using the PROG command)  
**Syntax:** **PROG:SAV**  
**Example:** **PROG:SAV**

## **PROG:STEP**

**Description:** Configures/Queries the step number in the sequence to setup.  
**Syntax:** **PROG:STEP<SP><number>**  
**PROG:STEP?**  
<number> - 1 – 150 (max.)  
**Example:** **PROG:STEP 10**  
Selects step number 10 for setup.  
**Query:** **PROG:STEP?**  
**Return String:** 30  
Currently selecting step 30 in the sequence for setup.  
**Format:** <number>

## **PROG:STEP:CURRent**

**Description:** Configures/Queries the current setting for the selected step (use PROG:STEP command to select step). For dual channel models, this will be for channel 1.

**Syntax:** **PROG:STEP:CURRent<SP><current>**  
**PROG:STEP:CURRent?**  
**<current>** - 0 – max. rated current.

**Example:** **PROG:STEP:CURR 1.234**  
Set 1.234 A as current setting for the selected step in the program sequence.

**Query:** **PROG:STEP:CURR?**

**Return String:** 1.234

**Format:** <NRf>

## **PROG:STEP:CURR2**

**Note:** For dual channel models only.

**Description:** Configures/Queries the current setting for the selected step (use PROG:STEP command to select step) for channel 2.

**Syntax:** **PROG:STEP:CURR2<SP><current>**  
**PROG:STEP:CURR2?**  
**<current>** - 0 – max. rated current.

**Example:** **PROG:STEP:CURR2 1.234**  
Set 1.234 A as current setting for the selected step in the program sequence for channel 2.

**Query:** **PROG:STEP:CURR2?**

**Return String:** 1.234

**Format:** <NRf>

## **PROG:STEP:ONTime**

**Description:** Configures/Queries the step timing (the length of period to hold the settings) of the selected sequence.

Unit is in seconds.  
**Syntax:** **PROG:STEP:ONTime<SP><seconds>**  
**PROG:STEP:ONTime?**  
**<seconds>** - 0.010 – 2000 (max.)

**Example:** **PROG:STEP:ONT 0.050**  
Set the selected step time to 0.050 seconds (50 ms).

**Query:** **PROG:STEP:ONT?**

**Return String:** 0.050

**Format:** <seconds>

### **PROG:STEP:VOLTage**

**Description:** Configures/Queries the voltage setting for the selected step (use PROG:STEP command to select step). For dual channel models, this will be for channel 1.

**Syntax:** **PROG:STEP:VOLTage<SP><voltage>**  
**PROG:STEP:VOLTage?**  
**<voltage>** - 0 – max. rated voltage.

**Example:** **PROG:STEP:VOLT 1.234**  
Set 1.234 V as voltage setting for the selected step in the program sequence.

**Query:** **PROG:STEP:VOLT?**

**Return String:** 1.234

**Format:** <NRf>

### **PROG:STEP:VOLT2**

**Note:** For dual channel models only.

**Description:** Configures/Queries the voltage setting for the selected step (use PROG:STEP command to select step) for channel 2.

**Syntax:** **PROG:STEP:VOLT2<SP><voltage>**  
**PROG:STEP:VOLT2?**  
**<voltage>** - 0 – max. rated voltage.

**Example:** **PROG:STEP:VOLT2 1.234**  
Set 1.234 V as voltage setting for the selected step in the program sequence.

**Query:** **PROG:STEP:VOLT2?**

**Return String:** 1.234

**Format:** <NRf>

### **PROG:TOTAL**

**Description:** Configures/Queries the total number of step numbers

for the program sequence.

**Syntax:** **PROG:TOTAL<SP><number>**  
**PROG:TOTAL?**  
<number> - 2 -150 (max.)

**Example:** **PROG:TOTA 100**  
Setup a program sequence with 100 steps.

**Query:** **PROG:TOTA?**

**Return String:** 30  
Currently the sequence will have 30 steps for setup.

**Format:** <NR1>

## ***Protection Subsystem***

### **PROTection**

**Note:** See **STATUS** command in the next section.

### **PROTection:CLEar**

**Description:** Clears/resets all latched protection (when protection is flagged/tripped)

**Syntax:** **PROTection:CLEar**

**Example:** **PROT:CLE**

### **PROTection:OCP**

**Description:** Configure/Query the state of OCP (over current protection).

**Syntax:** **PROTection:OCP<SP><Boolean>**  
**PROT:OCP?**

**Example:** **PROT 1**  
**PROT ON**  
Enables OCP

**Query:** **PROT:OCP?**

**Return String:** OFF  
Currently OCP is disabled.

**Format:** ON or OFF

### **PROTection:OCP:LEVel**

**Description:** Configures/Queries the current level for OCP.

**Syntax:** **PROTection:OCP:LEVel<SP><current>**

**PROTection:OCP:LEVel?**  
 <current> - 0 – max. rated current.

**Example:** **PROT:OCP:LEV 3.000**  
 Set 3.000 A as the OCP current level.

**Query:** **PROT:OCP:LEV?**

**Return String:** 3.000

**Format:** <NRf>

## PROTection:OCP2

**Note:** For dual channel models only.

**Description:** Configures/Queries the state of OCP channel 2.

**Syntax:** **PROTection:OCP2<SP><Boolean>**  
**PROT:OCP2?**

**Example:** **PROT 1**  
**PROT ON**  
 Enables OCP on channel 2.

**Query:** **PROT:OCP?**

**Return String:** OFF  
 Currently OCP for channel 2 is disabled.

**Format:** ON or OFF

## PROTection:OCP2:LEVel

**Note:** For dual channel models only.

**Description:** Configures/Queries the current level for OCP for channel 2.

**Syntax:** **PROTection:OCP2:LEVel<SP><current>**  
**PROTection:OCP2:LEVel?**  
 <current> - 0 – max. rated current.

**Example:** **PROT:OCP2:LEV 3.000**  
 Set 3.000 A as the OCP current level for channel 2.

**Query:** **PROT:OCP2:LEV?**

**Return String:** 3.000

**Format:** <NRf>

## PROTection:OVP

**Description:** Configure/Query the state of OVP (over voltage protection).

**Syntax:** **PROTection:OVP<SP><Boolean>**  
**PROT:OVP?**

**Example:**           **PROT 1**  
                  **PROT ON**  
                  Enables OVP  
**Query:**           **PROT:OVP?**  
**Return String:**   OFF  
                  Currently OVP is disabled.  
**Format:**           ON or OFF

### **PROTection:OVP:LEVel**

**Description:**    Configures/Queries the voltage level for OVP.  
**Syntax:**        **PROTection:OVP:LEVel<SP><voltage>**  
                  **PROTection:OVP:LEVel?**  
                  <voltage> - 0 – max. rated voltage.  
**Example:**        **PROT:OVP:LEV 20.000**  
                  Set 20.000 V as the OVP voltage level.  
**Query:**           **PROT:OVP:LEV?**  
**Return String:**   20.000  
**Format:**        <NRf>

### **PROTection:OVP2**

**Note:**            For dual channel models only.  
**Description:**    Configure/Query the state of OVP (over voltage protection) for channel 2.  
**Syntax:**        **PROTection:OVP2<SP><Boolean>**  
                  **PROT:OVP2?**  
**Example:**        **PROT 1**  
                  **PROT ON**  
                  Enables OVP for channel 2.  
**Query:**           **PROT:OVP2?**  
**Return String:**   OFF  
                  Currently OVP is disabled for channel 2.  
**Format:**        ON or OFF

### **PROTection:OVP2:LEVel**

**Note:**            For dual channel models only.  
**Description:**    Configures/Queries the voltage level for OVP for channel 2.  
**Syntax:**        **PROTection:OVP2:LEVel<SP><voltage>**  
                  **PROTection:OVP2:LEVel?**

**Example:** <voltage> - 0 – max. rated voltage.  
**PROT:OVP2:LEV 20.000**  
Set 20.000 V as the OVP voltage level for channel 2.

**Query:** **PROT:OVP2:LEV?**

**Return String:** 20.000

**Format:** <NRf>

## **Source Subsystem**

### **[SOURce]:CURRent**

**Description:** Configures/Queries the ISET current setting. For dual channel models, use [SOURce]:CURR2 command for channel 2.

**Syntax:** **[SOURce]:CURRent<SP><current>**  
**[SOURce]:CURRent?**  
<current> - 0 – max. rated current.

**Example:** **SOUR:CURR 1.456**  
Set current to 1.456 A.

**Query:** **SOUR:CURR?**

**Return String:** 1.456

**Format:** <NRf>

### **[SOURce]:CURRent:PROTection**

**Note:** See **PROTection:OCP** command.

### **[SOURce]:CURRent:PROTection:LEVel**

**Note:** See **PROTection:OCP:LEVel** command.

### **[SOURce]:CURR2**

**Note:** For dual channel models only.

**Description:** Configures/Queries the ISET current setting for channel 2.

**Syntax:** **[SOURce]:CURR2<SP><current>**  
**[SOURce]:CURR2?**  
<current> - 0 – max. rated current.

**Example:** **SOUR:CURR21.456**  
Set current of channel 2 to 1.456 A.

**Query:** SOUR:CURRE2?  
**Return String:** 1.456  
**Format:** <NRf>

### **[SOURce]:CURRE2:PROTection**

**Note:** See PROTection:OCP2 command.

### **[SOURce]:CURRE2:PROTection:LEVel**

**Note:** See PROTection:OCP2:LEVel command.

### **[SOURce]:VOLTage**

**Description:** Configures/Queries the VSET voltage setting. For dual channel models, use [SOURce]:VOLT2 command for channel 2.

**Syntax:** [SOURce]:VOLTage<SP><voltage>  
[SOURce]:VOLTage?  
<voltage> - 0 – max. rated voltage.

**Example:** SOUR:VOLT20.000  
Set voltage to 20.000 V.

**Query:** SOUR:VOLT?  
**Return String:** 20.000  
**Format:** <NRf>

### **[SOURce]:VOLTage:PROTection**

**Note:** See PROTection:OVP command.

### **[SOURce]:VOLTage:PROTection:LEVel**

**Note:** See PROTection:OVP:LEVel command.

### **[SOURce]:VOLTage:RANGe**

**Note:** This command is for models 9184 and 9185 only.

**Description:** Configures/Queries the voltage range.

**Syntax:** [SOURce]:VOLTage:RANGe<SP><range>  
[SOURce]:VOLTage:RANGe?



**Example:** <range> - 0 or 1 / LOW or HIGH  
**SOUR:VOLT:RANG LOW**  
**SOUR:VOLT:RANG 0**  
Set the supply to the low voltage range.

**Query:** **SOUR:VOLT:RANG?**  
**Return String:** LOW  
**Format:** <range>

## **[SOURce]:VOLT2**

**Note:** For dual channel models only.  
**Description:** Configures/Queries the VISET voltage setting for channel 2.

**Syntax:** **[SOURce]:VOLT2<SP><voltage>**  
**[SOURce]:VOLT2?**  
<voltage> - 0 – max. rated voltage.

**Example:** **SOUR:VOLT220.000**  
Set voltage of channel 2 to 20.000 V.

**Query:** **SOUR:VOLT2?**  
**Return String:** 20.000  
**Format:** <NRf>

## **[SOURce]:VOLT2:PROTection**

**Note:** See **PROTection:OVP2** command.

## **[SOURce]:VOLT2:PROTection:LEVel**

**Note:** See **PROTection:OVP2:LEVel** command.

## **System Subsystem**

### **SYStem:AVErage**

**Description:** Configures/Queries the measurement average setting.

**Syntax:** **[SYStem]:AVErage<SP><number>**  
**[SYStem]:AVErage?**  
<number> - 1 – 10 are valid numbers.

**Example:** **SYS:AVE2**  
Set measurement average to 2.

**Query:** **SYS:AVE?**

**Return String:** 2  
**Format:** <NR1>

### **SYStem:BEEP**

**Description:** Configure/Query the state of the key sound.  
**Syntax:** **SYStem:BEEP<SP><Boolean>**  
**SYStem:BEEP?**  
**Example:** **SYS:BEEP 0**  
**SYS:BEEP OFF**  
Disables the key sound.  
**Query:** **SYS:BEEP?**  
**Return String:** OFF  
Key sound is disabled.  
**Format:** ON or OFF

### **SYStem:ERRor?**

**Description:** Queries the error from the error queue.  
**Syntax:** **SYStem:ERRor?**  
**Return Syntax:** <number> - 0 – 4. Refer to their description in the table below.  
**Query:** **SYS:ERR?**  
**Return String:** 0  
No errors.  
**Format:** <number>

<b>Error Code</b>	<b>Description</b>
0	No Error
1	Command Error
2	Execution Error
3	Query Error
4	Input Range Error

## **SYSTem:EXTernal**

**Description:** Configure/Query the state/type of the analog external control.

**Syntax:** **SYSTem:EXTernal<SP><type>**  
**SYSTem:EXTernal?**  
**<type>** - 0/OFF, 1/VOLT, 2/RES

**Example:** **SYS:EXT 1**  
**SYS:EXT VOLT**  
Set to use voltage source for external analog control

**Query:** **SYS:EXT?**

**Return String:** 2  
Currently set to resistance external control.

**Format:** <type>

## **SYSTem:EXTernal:LEVel**

**Description:** Configure/Query voltage scale to use for external voltage control.

**Syntax:** **SYSTem:EXTernal:LEVel<SP><scale>**  
**SYSTem:EXTernal:LEVel?**  
**<scale>** - 0/V10 or 1/V5

**Example:** **SYS:EXT:LEV V10**  
**SYS:EXT:LEV 0**  
Selects 0-10 V scale to use for external voltage control.

**Query:** **SYS:EXT?**

**Return String:** 0  
0-10 V scale is selected.

**Format:** <scale>

## **SYSTem:GPIB:ADDRess**

**Description:** Configure/Query the GPIB address.

**Syntax:** **SYSTem:GPIB:ADDRess<SP><address>**

**SYStem:GPIB:ADDRes?**  
 <address> - 1 – 30 are valid numbers.

**Example:** **SYS:GPIB:ADDR 6**  
 Sets the GPIB address to 6.

**Query:** **SYS:GPIB:ADDR?**

**Return String:** 6

**Format:** <NR1>

### **SYStem:IP:ADDRes**

**Description:** Configure/Query the LAN IP address

**Syntax:** **SYStem:IP:ADDRes<SP><ip>**  
**SYStem:IP:ADDRes?**  
 <ip> - NR1.NR1.NR1.NR1. NR1 can be from 000 – 255.

**Example:** **SYS:IP:ADDR 192.168.001.150**  
 Sets the IP address to 192.168.1.150

**Query:** **SYS:IP:ADDR?**

**Return String:** 192.168.001.150

**Format:** <NR1>.<NR1>.<NR1>.<NR1>

### **SYStem:IP:CONFIg**

**Description:** Configure/Query the configuration of the IP.

**Syntax:** **SYStem:IP:CONFIg<SP><config>**  
**SYStem:IP:CONFIg?**  
 <config> - 0/STATIC

**Example:** **SYS:IP:CONF STAT**  
**SYS:IP:CONF 0**  
 Set the IP configuration to STATIC.

**Query:** **SYS:IP:CONF?**

**Return String:** 0

**Format:** <config>

### **SYStem:KEY:LOCK**

**Description:** Configures/Queries the state of the key lock.

**Syntax:** **SYStem:KEY:LOCK<SP><Boolean>**  
**SYStem:KEY:LOCK?**

**Example:** **SYS:KEY:LOCK ON**  
 Enables key lock.

**Query:** **SYS:KEY?**

**Return String:** ON  
**Format:** ON or OFF

### **SYStem:LCD:BL**

**Description:** Configures/Queries the LCD backlight state  
**Syntax:** **SYStem:LCD:BL<SP><state>**  
**SYStem:LCD:BL?**  
**<state>** - 0/ON, 1/OFF1, 2/OFF5, 3/OFF10, 4/OFF30  
(For Always ON, ON 1 minutes, ON 5 minutes, ON 10 minutes, ON 30 minutes respectively)  
**Example:** **SYS:LCD:BL**  
Enables key lock.  
**Query:** **SYS:KEY?**  
**Return String:** ON  
**Format:** ON or OFF

### **SYStem:LED**

**Description:** Configures/Queries the state of LED test mode.  
**Syntax:** **SYStem:LED<SP><Boolean>**  
**SYStem:LED?**  
**Example:** **SYS:LED ON**  
Enables LED mode.  
**Query:** **SYS:LED?**  
**Return String:** ON  
**Format:** ON or OFF

### **SYStem:LOW:CURR**

**Description:** For models 9184 and 9185 only. Configures/Queries the state of Low Current mode.  
**Syntax:** **SYStem:LOW:CURR<SP><Boolean>**  
**SYStem:LOW:CURR?**  
**Example:** **SYS:LOW:CURR ON**  
Enables low current mode.  
**Query:** **SYS:LOW:CURR?**

**Return String:** ON  
**Format:** ON or OFF

### **SYStem:OUTput:MODE**

**Note:** For dual channel models only.  
**Description:** Configures/Queries the state of the output mode.  
**Syntax:** **SYStem:OUTput:MODE<SP><state>**  
**SYStem:OUTput:MODE?**  
**<state>** - 0/MULTI or 1/SINGLE  
**Example:** **SYS:OUT:MODE 0**  
**SYS:OUT:MODE MULTI**  
Sets output mode to MULTI.  
**Query:** **SYS:OUT:MODE?**  
**Return String:** MULTI  
**Format:** SINGLE or MULTI

### **SYStem:RECall:DEFault**

**Description:** Resets back to default factory settings.  
**Syntax:** **SYStem:RECall:DEFault**  
**Example:** **SYS:REC:DEF**

### **SYStem:REMOte**

**Description:** Configures/Queries the selected remote interface  
**Syntax:** **SYStem:REMOte<SP><interface>**  
**SYStem:REMOte?**  
**<interface>** - USB, GPIB, ETHERNET  
**Example:** **SYS:REM GPIB**  
Changes remote interface to GPIB.  
**Query:** **SYS:REM?**  
**Return String:** GPIB  
**Format:** <interface>

## **SYStem:SERies?**

**Description:** Queries the serial number of the instrument.  
**Syntax:** **SYStem:SERies?**  
**Query:** **SYS:SER?**  
**Return String:** 123D12101  
Serial number of the instrument is 123D12101.

## **SYStem:TRACK**

**Note:** For dual channel models only.  
**Description:** Configures/Queries the state of tracking mode.  
**Syntax:** **SYStem:TRACK<SP><Boolean>**  
**SYStem:TRACK?**  
**Example:** **SYS:TRACK 1**  
**SYS:TRACK ON**  
Enables tracking mode.  
**Query:** **SYS:TRACK?**  
**Return String:** **ON**  
**Format:** ON or OFF

## ***Timer Subsystem***

### **TIMER**

**Description:** Configures/Queries the state of the output timer function. The timer starts once output is enabled.  
**Syntax:** **TIMER<SP><Boolean>**  
**TIMER?**  
**Example:** **TIMER ON**  
**TIMER 1**  
Enables timer output.  
**Query:** **TIMER?**  
**Return String:** **ON**  
**Format:** ON or OFF

### **TIMER:HOUR**

**Description:** Configures/Queries the output timer hours.  
**Syntax:** **TIMER:HOUR<SP><hour>**

**Example:** **TIMER:HOuR?**  
 <hour> - 0 - 999  
**TIMER:HOuR 100**  
 Sets the output timer to 100 hours.

**Query:** **TIMER:HOuR?**  
**Return String:** **100**  
**Format:** <NR1>

### **TIMER:MINute**

**Description:** Configures/Queries the output timer hours.  
**Syntax:** **TIMER:MINute<SP><hour>**  
**TIMER:MINute?**  
 <hour> - 0 - 59

**Example:** **TIMER:MIN 40**  
 Sets the output timer to 40 minutes.

**Query:** **TIMER:MIN?**  
**Return String:** **40**  
**Format:** <NR1>

### **TIMER:SECOnd**

**Description:** Configures/Queries the output timer seconds.  
**Syntax:** **TIMER:SECOnd<SP><hour>**  
**TIMER:SECOnd?**  
 <hour> - 0 – 59

**Example:** **TIMER:SEC 20**  
 Sets the output timer to 20 seconds.

**Query:** **TIMER:SEC?**  
**Return String:** **20**  
**Format:** <NR1>

## **Standard Commands**

The following commands are instrument specific and apply to all models, with the exception of some that apply to dual channel models only (see the notes under some of the commands for details). Most of these commands function the same way as most of



the SCPI commands described in the previous section. For example, **MEASure:CURRent?** functions the same as **IOUOut?**.

## **ADDRes**

**Description:** Configures/Queries the GPIB address  
**Syntax:** **ADDRes<SP><address>**  
**ADDRes?**  
**<address>** - GPIB address. 0 – 30 are valid addresses.

**Example:** **ADDR 10**  
Sets the GPIB address to 10.

**Query:** **ADDR?**  
**Return String:** 10  
**Format:** <NR1>

## **BEEP**

**Description:** Configures/Queries the key sound state  
**Syntax:** **BEEP<SP><state>**  
**BEEP?**  
**<state>** - ON or 1 to turn ON  
- OFF or 0 to turn OFF

**Example:** **BEEP ON**  
Turns on key beep.

**Query:** **BEEP?**  
**Return String:** ON  
**Format:** <state>

## **CLR**

**Description:** Clear protection status  
**Example:** **CLR**

## **CHANnel**

**Note:** This command is for dual channel models only.  
**Description:** Selects the channel to configure.

**Syntax:** CHANnel<SP><channel>  
 CHANnel?  
 <channel> - 1 or 2.

**Example:** CHAN 2  
 Selects channel 2.

**Query:** CHAN?

**Return String:** 1

**Format:** <channel>

## CURRent/CURR2

**Note:** CURR2 command is for dual channel models only.

**Description:** Configures/Queries the ISET current setting. For dual channel models, use CURR2 command for channel 2.

**Syntax:** CURRent<SP><current>  
 CURR2<SP><current>  
 CURRent?  
 CURR2?  
 <current> - 0 – max. rated current output

**Example:** CURR2 1.234  
 Sets the second channel ISET current to 1.234 A on a dual channel model.

**Query:** CURR?

**Return String:** 1.234

**Format:** <NRf>

## ERRor?

**Description:** Queries system errors

**Syntax:** ERRor?

**Example:** ERR?

**Return String:** 0  
 Refer to the table below for error description.

**Format:** <NR1>

Error Code	Description
0	No Error
1	Command Error
2	Execution Error
3	Query Error

**IOUT?/IOUT2?**

**Note:** IOUT2 command is for dual channel models only.  
**Description:** Queries the measured/readback current output value. For dual channel models, use IOUT2 command for channel 2.  
**Syntax:** **IOUT?**  
**IOUT2?**  
**Example:** **IOUT?**  
**Return String:** 2.156  
 Output current measured is 2.156 A.  
**Format:** <NRf>

**ISET/ISET2**

**Description:** This command is the same as CURRENT/CURR2 command. See CURRENT/CURR2 for details.  
**Example:** ISET?  
 ISET 1.234  
**Format:** <NRf>

**LOCK**

**Description:** Configures the key lock state  
**Syntax:** **LOCK<SP><state>**  
**<state>** - ON or 1 to turn ON  
 - OFF or 0 to turn OFF  
**Example:** **LOCK 1**  
 Turns on key lock.

**MODEL?**

**Description:** Queries the model number

**Syntax:** MODEL?  
**Example:** MODEL?  
**Return String:** 9174  
**Format:** <model>

## OCP/OCP2

**Note:** OCP2 command is for dual channel models only.  
**Description:** Configures/Queries the over current protection state. For dual channel models, use OCP2 command for channel 2.

**Syntax:** OCP<SP><state>  
OCP2<SP><state>  
OCP?  
OCP2?  
<state> - ON or 1 to turn ON  
- OFF or 0 to turn OFF

**Example:** OCP2 ON  
Enables OCP for channel 2 on a dual channel model.

**Query:** OCP?  
OCP2?

**Return String:** OFF

**Format:** <state>

## OISET/OISET2

**Note:** OISET2 command is for dual channel models only.  
**Description:** Configures/Queries the over current protection value. For dual channel models, use OISET2 command for channel 2.

**Syntax:** OISET<SP><current>  
OISET2<SP><current>  
OISET?  
OISET2?  
<current> - 0 – max. rated current

**Example:** OISET 9.124  
Sets OCP protection to 9.124 A .

**Query:** OISET?  
OISET2?

**Return String:** 9.124  
OCP is set to 9.124 A.

**Format:** <NRf>

## OUT/OUT2

**Note:** OUT2 command is for dual channel models only.

**Description:** Configures/Queries the output state. For dual channel models, use OUT2 command to configure/query channel 2 output state.

**Syntax:** **OUT<SP><state>**  
**OUT2<SP><state>**  
**OUT?**  
**OUT2?**

**<state>** - ON or 1 to turn ON  
- OFF or 0 to turn OFF

**Example:** **OUT 1**  
Turns ON (enables) the output

**Query:** **OUT?**  
**OUT2?**

**Return String:** ON  
Output is enabled.

**Format:** <state>

## OUTM/OUTM?

**Note:** This command is for dual channel models only.

**Description:** Configures/Queries the output mode for multi or single output control for dual channel models.

**Syntax:** **OUTM<SP><mode>**  
**OUTM?**  
**<mode>** - SINGLE or 1 for single channel output control  
- MULTI or 0 for dual channel output control (control both channels' output state simultaneously)

**Example:** **OUTM 1**  
Sets the output mode to SINGLE

**Query:** **OUTM?**  
**Return String:** SINGLE

**Format:** <mode>

## OVP/OVP2

**Note:** OVP2 command is for dual channel models only.  
**Description:** Configures/Queries the over voltage protection state. For dual channel models, use OVP2 command for channel 2.  
**Syntax:** **OVP<SP><state>**  
**OVP2<SP><state>**  
**OVP?**  
**OVP2?**  
<state> - ON or 1 to turn ON  
          - OFF or 0 to turn OFF  
**Example:** **OVP2 ON**  
Enables OVP for channel 2 on a dual channel model.  
**Query:** **OVP?**  
**OVP2?**  
**Return String:** ON  
**Format:** <state>

## OVSET/OVSET2

**Note:** OVSET2 command is for dual channel models only.  
**Description:** Configures/Queries the over voltage protection value. For dual channel models, use OVSET2 command for channel 2.  
**Syntax:** **OVSET<SP><voltage>**  
**OVSET2<SP><voltage>**  
**OVSET?**  
**OVSET2?**  
<voltage> - 0 – max. rated voltage  
**Example:** **OVSET 70.000**  
Sets OVP protection to 70.000 V  
**Query:** **OVSET?**  
**OVSET2?**  
**Return String:** 70.000

**Format:** OVP is set to 70.000 V  
<NRf>

## STATUS?

**Description:** Queries the instrument status

**Syntax:** STATUS?

**Example:** STATUS?

**Return String:** 000000

No OVP, OCP, OTP, and other failure or flagged status. Outputs are off, LCD backlight always ON, and output mode set to MULTI.

**Format:** <byte2><byte1><byte0>  
Refer to the table and description below for details on the returned data.

When **STATUS?** command is used, the power supply will return an ASCII string of 6 alphanumeric characters, which is a representation of 3-bytes data encoded in hex. The binary representation of each byte indicates different statuses of the power supply. See the table below:

Byte #	Bits	Description	Bit Value Description
2	0-7	System Reserved	-
1	7	Channel 1 OVP flag status	1 is flag, 0 is no flag
	6	Channel 2 OVP flag status	1 is flag, 0 is no flag
	5	Channel 1 OCP flag status	1 is flag, 0 is no flag
	4	Channel 2 OCP flag status	1 is flag, 0 is no flag
	3	Fan failure flag status	1 is flag, 0 is no flag
	2	AC range error flag status	1 is flag, 0 is no flag
	1	OTP flag status	1 is flag, 0 is no flag
	0	NTC flag status	1 is flag, 0 is no flag

0	7	Channel 1 OVP On/Off status	1 is ON, 0 is OFF
	6	Channel 2 OVP On/Off status	1 is ON, 0 is OFF
	5	Channel 1 OCP On/Off status	1 is ON, 0 is OFF
	4	Channel 2 OCP On/Off status	1 is ON, 0 is OFF
	3	Channel 1 output On/Off status	1 is ON, 0 is OFF
	2	Channel 2 output On/Off status	1 is ON, 0 is OFF
	1	LCD backlight On/Off Status	0 – Always ON, 1 – Timed
	0	Output mode Single/Multi status	0 – MULTI, 1 – SINGLE

### Example 2:

**Return string: 00008C**

Byte 2: 0

Byte 1: 0

Byte 0: 8C

8C = 10001100 (bits 7 – bit 0)

### Representation:

- Channel 1 OVP status is ON
- Channel 1 output is ON
- Channel 2 output is ON
- LCD backlight is ALWAYS ON
- Output mode is MULTI
- No protection flag status (instrument is operating normally)

### TRACK

**Note:** This command is for dual channel models only.

**Description:** Configures/Queries the tracking mode state.

**Syntax:** TRACK<SP><state>

TRACK?

<state> - ON or 1 to turn ON

- OFF or 0 to turn OFF



**Example:** **TRACK ON**  
Turns ON (enables) tracking mode.  
**Query:** **TRACK?**  
**Return String:** ON  
**Format:** <state>

## VERsion?

**Description:** Queries the firmware version  
**Syntax:** **VERsion?**  
**Example:** **VERsion?**  
**Return String:** 1.10  
**Format:** <NRf>

## VOLTage/VOLT2

**Note:** VOLT2 command is for dual channel models only.  
**Description:** Configures/Queries the VSET voltage setting. For dual channel models, use VOLT2 command for channel 2.  
**Syntax:** **VOLTage<SP><voltage>**  
**VOLT2<SP><voltage>**  
**VOLTage?**  
**VOLT2?**  
**<voltage>** - 0 – max. rated voltage output  
**Example:** **VOLT2 12.000**  
Sets the second channel VSET voltage to 12.000 V on a dual channel model.  
**Query:** **VOLT?**  
**Return String:** 12.000  
**Format:** <NRf>

## VOUT?/VOUT2?

**Note:** VOUT2 command is for dual channel models only.  
**Description:** Queries the measured/readback voltage output value. For dual channel models, use VOUT2 command for channel 2.  
**Syntax:** **VOUT?**  
**VOUT2?**  
**Example:** **VOUT?**  
**Return String:** 10.002  
Output voltage measured is 10.002 V.

**Format:** <NRf>

### VSET/VSET2

**Description:** This command is the same as VOLTage/VOLT2 command. See VOLTage/VOLT2 for details.

**Example:** VSET?  
VSET 12.345

**Format:** <NRf>

## 4.3 Sequence Programming

The power supply has the ability to store custom programmed sequences and run them, as described in “3.11 Sequence Program Mode”. This section provides some examples of how to create some sequences using remote commands described in the previous section.

### *Examples*

#### **Example 1:**

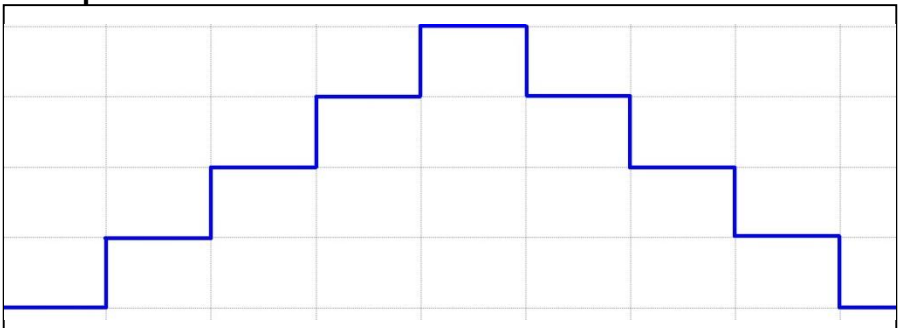

To create an output sequence like above, send the following list of commands in order:

PROG 1	Choose program number
PROG:CLE	Clear program 1 data
PROG:REP 0	No repeat (repeat one time for "1")
PROG:TOTA 8	Set program 1 to have 8 steps in total
PROG:STEP 1	Following 3 settings are for step 1
PROG:STEP:CURR 1	Set output current to 1 ampere
PROG:STEP:VOLT 5	Output voltage is set to 5 volts
PROG:STEP:ONT 0.1	Output ON time is set to 0.1 sec
PROG:STEP 2	Following 3 settings are for step 2
PROG:STEP:CURR 1	
PROG:STEP:VOLT 10	
PROG:STEP:ONT 0.1	
PROG:STEP 3	Choose step 3
PROG:STEP:CURR 1	
PROG:STEP:VOLT 15	
PROG:STEP:ONT 0.1	
PROG:STEP 4	Choose step 4
PROG:STEP:CURR 1	
PROG:STEP:VOLT 20	
PROG:STEP:ONT 0.1	
PROG:STEP 5	Choose step 5
PROG:STEP:CURR 1	
PROG:STEP:VOLT 15	
PROG:STEP:ONT 0.1	
PROG:STEP 6	Choose step 6
PROG:STEP:CURR 1	
PROG:STEP:VOLT 10	
PROG:STEP:ONT 0.1	
PROG:STEP 7	Choose step 7
PROG:STEP:CURR 1	
PROG:STEP:VOLT 5	

PROG:STEP:ONT 0.1	
PROG:STEP 8	Choose step 8
PROG:STEP:CURR 1	
PROG:STEP:VOLT 0	
PROG:STEP:ONT 0.1	
PROG:NEXT 0	Select next program to run after program 1 is complete, 0 means Stop
PROG:SAV	After edit, use Save command to store program 1 in the hardware
PROG 1 PROG:RUN ON	Select program 1 Use RUN ON command to execute

**Example 2:**

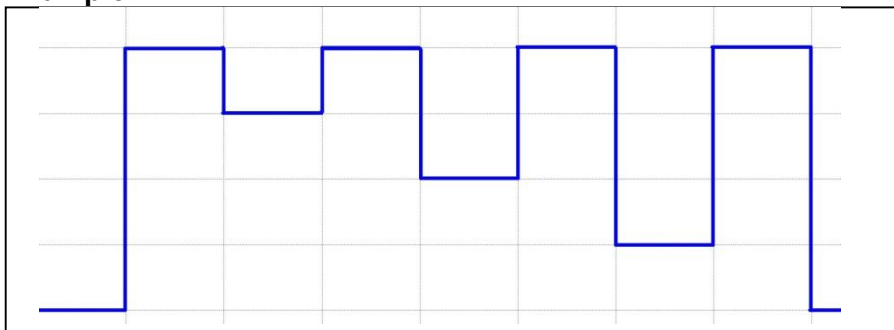

To create an output sequence like above, send the following list of commands in order:

PROG 2	Choose program number
PROG:CLE	Clear program 2 data
PROG:REP 0	No repeat after running this program
PROG:TOTA 8	Set program 2 to have 8 steps in total
PROG:STEP 1	Settings for step 1
PROG:STEP:CURR 2	Set output current to 2 amperes
PROG:STEP:VOLT 20	Set output voltage to 20 volts
PROG:STEP:ONT 0.5	Set output ON time to 0.5 sec
PROG:STEP 2	Choose step 2

PROG:STEP:CURR 2	
PROG:STEP:VOLT 15	
PROG:STEP:ONT 0.5	
PROG:STEP 3	Settings for step 3
PROG:STEP:CURR 2	
PROG:STEP:VOLT 20	
PROG:STEP:ONT 0.5	
PROG:STEP 4	Choose step 4
PROG:STEP:CURR 2	
PROG:STEP:VOLT 10	
PROG:STEP:ONT 0.5	
PROG:STEP 5	Choose step 5
PROG:STEP:CURR 1	
PROG:STEP:VOLT 20	
PROG:STEP:ONT 0.5	
PROG:STEP 6	Choose step 6
PROG:STEP:CURR 2	
PROG:STEP:VOLT 5	
PROG:STEP:ONT 0.5	
PROG:STEP 7	Choose step 7
PROG:STEP:CURR 2	
PROG:STEP:VOLT 20	
PROG:STEP:ONT 0.5	
PROG:STEP 8	Choose step 8
PROG:STEP:CURR 2	
PROG:STEP:VOLT 0	
PROG:STEP:ONT 0.5	
PROG:NEXT 0	Select next program to run after program 2 is complete, 0 means stop
PROG:SAV	After edit, use Save command to store program 2 in the hardware
PROG 2 PROG:RUN ON	Select program 2 Use RUN ON command to execute

**Example 3:**

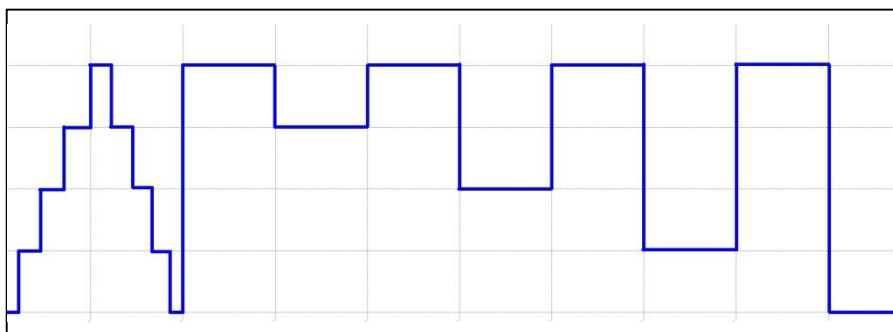

To execute example 2 sequence after example 1 sequence, then modify sequence of example 1 with NEXT 2 command. Send the following steps to modify and execute the program to generate a waveform sequence shown above.

PROG 1	Select program 1
PROG:NEXT 2	Change the NEXT command from NEXT 0 to NEXT 2
PROG:SAV	After edit is complete use Save command to store changes in the hardware
PROG 1 PROG:RUN ON	Select program 1 Use RUN ON command to execute

## 4.4 Multi Unit Programming

The instrument can be connected together with multiple units via RS-485 interface, as described in section “3.2 Remote Interface Setup” under “RS-485 Interface” and be controlled via a single USB connection between the PC and one of the power supplies. The setup is illustrated below:

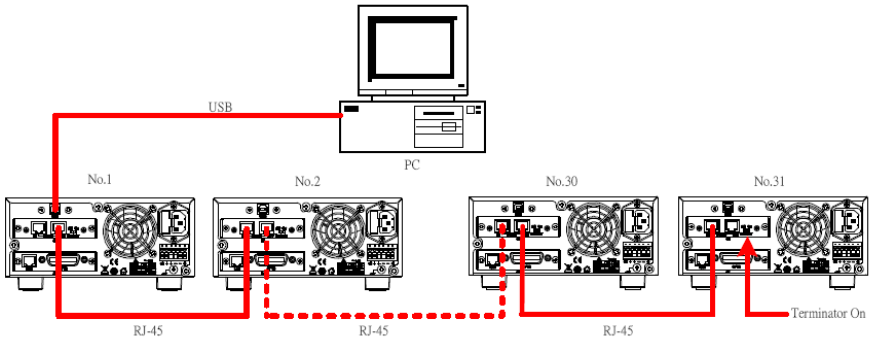

**Figure 30- Multi Unit Programming**

The following describes the specific commands that may be used to communicate with each connected instrument with this specific setup.

### ***Remote Commands via USB***

The following lists all the available commands to control multiple power supplies with the multi unit programming configuration illustrated in “Figure 30”. For all configuration commands (except for commands listed under **Synchronous Control Commands** section), the instrument will return a string “OK” to indicate command sent successfully. If an error occurs, it will return an error. See the “Error List” section for details.

### ***System Control Command***

This set of commands is used to select the instrument (based on their address) to control and to obtain/set its system settings.

**CADR**  
**CCLS**  
**CRST**  
**CIDN?**  
**CREV**  
**CSN?**  
**CST?**  
**CCLR**

**CADR**

**Note:** This command must be used first prior to any other commands to control individually addressed power supplies with RS-485 connection.

**Description:** Selects the address of the power supply to be controlled.

**Syntax:** **CADR<SP><address>**  
**<address>** - 1 – 31 are valid numbers.

**Example:** **CADR 5**  
This will select power supply with address = 5.

**CCLS**

**Description:** Clears the status of the selected power supply.

**Syntax:** **CCLS**

**CRST**

**Description:** Resets the selected power supply to a known state.

**Syntax:** **CRST**

**CIDN?**

**Description:** Queries the IDN information of the selected power



supply. This command functions the same as \*IDN?, however this is used in a multi unit programming setup for the selected power supply.

**Query:** **CIDN?**  
**Return String:** **B&K PRECISION,9171,SN#,1.10,0**

### **CREV?**

**Description:** Queries the firmware version of the selected power supply.

**Query:** **CREV?**  
**Return String:** **1.10**

### **CSN?**

**Description:** Queries the serial number of the selected power supply.

**Query:** **CSN?**  
**Return String:** **123D19238**  
Serial number is 123D19238.

### **CST?**

**Description:** Queries the status of the selected power supply. This command functions the same as STATUS? command, however this is used in a multi unit programming setup for the selected power supply.

**Query:** **CST?**

### **CCLR**

**Description:** Clears the protection flag/trip of the selected power supply.

**Syntax:** **CCLR**

## ***Output Control Command***

This set of commands controls the outputs of the selected instrument (based on their address). Use **CADR** command(described in previous section) first to select the address of the unit you want to control before using any of these commands

to control that unit's output.

**CPV/CPV2**

**CMV?/CMV2?**

**CPC/CPC2**

**CMC?/CMC2?**

**CDVC?/CDVC2?**

**COUT/COUT2**

**COUTA**

**COV/COV2**

**COVP/COVP2**

**COC/COC2**

**COCP/COCP2**

**CMODE?/CMODE2?**

**CPV/CPV2**

**Description:** Configures/Queries the VSET voltage setting of the selected power supply. See **VOLTage/VOLT2** command for similar syntax. **CPV2** is for dual channel models only.

**Example:** **CPV 15.698**  
Sets the selected power supply's VSET voltage setting to 15.698 V.

**CPV2?**  
Queries the selected power supply's second channel VSET voltage setting.

**CMV?/CMV2?**

**Description:** Queries the measured/readback voltage output value of the selected power supply. See **VOUT?/VOUT2?** Command for similar syntax. **CMV2?** is for dual channel models only.

**Query:** **CMV?**  
**Return String:** **1.234 V**

The selected power supply has a measured output voltage of 1.234 V.

## **CPC/CPC2**

**Description:** Configures/Queries the ISET current setting of the selected power supply. See **CURRENT/CURR2** command for similar syntax. **CPC2** is for dual channel models only.

**Example:** **CPC 3.123**  
Sets the selected power supply's ISET current setting to 3.123 A.

**CPC2?**  
Queries the selected power supply's second channel ISET current setting.

## **CMC?/CMC2?**

**Description:** Queries the measured/readback current output value of the selected power supply. See **IOUT?/IOUT2?** Command for similar syntax. **CMC2?** is for dual channel models only.

**Query:** **CMC?**

**Return String:** **1.234 A**  
The selected power supply has a measured output current of 1.234 A.

## **CDVC?/CDVC2?**

**Description:** Queries the display voltage and current of the selected power supply. **CDVC2?** is for dual channel models only.

**Example:** **CDVC?**  
Queries channel 1 for dual channel models, or single channel.

**CDVC2?**  
Queries channel 2 for dual channel models.

**Return String:** 10.234,1.567  
Display voltage is 10.234 V and current is 1.567 A.

**Format:** <voltage>,<current>

## **COUT/COU2**

**Description:** Configures/Queries the output state of the selected power supply. See **OUT/OUT2** command for similar syntax. **COU2** is for dual channel models only.

**Example:** **COU ON**  
Sets the selected power supply's output to ON.  
**COU2?**  
Queries the selected power supply's second channel output state.

## **COUTA**

**Note:** For dual channel models only.

**Description:** Configures the output state of both channels of the selected power supply.

**Example:** **COUTA ON**  
Enables both channel outputs of the selected dual channel power supply.

## **COV/COV2**

**Description:** Configures/Queries the over voltage protection value of the selected power supply. See **OVSET/OVSET2** command for similar syntax. **COV2** is for dual channel models only.

**Example:** **COV 70.000**  
Sets the selected power supply's OVP value to 70.000V.  
**COV2?**  
Queries the selected power supply's second channel OVP value.

## **COVP/COVP2**

**Description:** Configures/Queries the over voltage protection state of the selected power supply. See **OVP/OVP2** command for similar syntax. **COVP2** is for dual channel models only.

**Example:** **COVP ON**  
Sets the selected power supply's OVP state to ON.  
**COVP2?**  
Queries the selected power supply's second channel OVP state.

## **COC/COC2**

**Description:** Configures/Queries the over current protection value of the selected power supply. See **OISET/OISET2** command for similar syntax. **COC2** is for dual channel models only.

**Example:** **COC 3.000**  
Sets the selected power supply's OCP value to 3.000 A.

**COC2?**  
Queries the selected power supply's second channel OCP value.

## **COCP/COCP2**

**Description:** Configures/Queries the over current protection state of the selected power supply. See **OCP/OCP2** command for similar syntax. **COCP2** is for dual channel models only.

**Example:** **COCP ON**  
Sets the selected power supply's OCP state to ON.

**COCP2?**  
Queries the selected power supply's second channel OCP state.

## **CMODE?/CMODE2?**

**Description:** Queries the output mode (CV or CC) of the selected power supply. **CMODE2?** Is for dual channel models only.

**Query:** **CMODE?**  
Queries channel 1 for dual channel models, or single channel.

**CMODE2?**  
Queries channel 2 for dual channel models.

**Return String:** CV

**Format:** CV or CC

## **Examples**

Here are a few examples of how to configure/query an instrument connected in the RS-485 chain.

- **Query the IDN information for power supply with address 3**

CADR 3

CIDN?

- **Configure ISET current of a dual channel supply with address 10 to 1.234 A.**

CADR10

CPC2 1.234

Return String: OK

- **Enable both channels' output for a dual channel supply with address 2**

CADR 2

COUTA ON

Return String: OK

- **Query the measured/readback current output of power supply with address 6**

CADR 6

CMC?

## ***Synchronous Control Command***

This set of commands can be used to control all the power supplies

connected in the RS-485 chain at once. Note that these commands will not return an “OK” string upon making a configuration.

## **GRST**

## **GCLS**

## **GCLR**

## **GPV/GPV2**

## **GPC/GPC2**

## **GOUT/GOUT2**

## **GOUTA**

## **GOV/GOV2**

## **GOVP/GOVP2**

## **GOC/GOC2**

## **GOCP/GOCP2**

## **GRST**

**Description:** Resets all the power supplies connected in the chain to a known state.

**Syntax:** **GRST**

## **GCLS**

**Description:** Clears the status of all the power supplies connected in the chain.

**Syntax:** **GCLS**

## **GCLR**

**Description:** Clears the protection flag/trip of all the power supplies connected in the chain.

**Syntax:** **GCLR**

## **GPV/GPV2**

**Description:** Configures/Queries the VSET voltage setting of all the power supplies connected in the chain. See **VOLTage/VOLT2** command for similar syntax. **GPV2** is for dual channel models only.

**Example:** **GPV 15.698**  
Sets all the power supplies' VSET voltage setting to 15.698 V.

## **GPC/GPC2**

**Description:** Configures/Queries the ISET current setting of all the power supplies connected in the chain. See **CURRENT/CURR2** command for similar syntax. **GPC2** is for dual channel models only.

**Example:** **GPC 3.123**  
Sets all the power supplies' ISET current setting to 3.123 A.

## **GOUT/GOUT2**

**Description:** Configures/Queries the output state of all the power supplies in the chain. See **OUT/OUT2** command for similar syntax. **GOUT2** is for dual channel models only.

**Example:** **GOUT ON**  
Sets all the power supplies' output to ON.

## **GOUTA**

**Note:** For dual channel models only.

**Description:** Configures the output state of both channels of the selected power supply.

**Example:** **GOUTA ON**  
Enables both channel outputs of all the dual channel power supplies in the chain.

## **GOV/GOV2**

**Description:** Configures/Queries the over voltage protection value of all the power supplies connected in the chain. See



**OVSET/OVSET2** command for similar syntax. **GOV2** is for dual channel models only.

**Example:**

**GOV 70.000**

Sets all the power supplies' OVP value to 70.000V.

## **GOVP/GOVP2**

**Description:**

Configures/Queries the over voltage protection state of all the power supplies connected in the chain. See **OVP/OVP2** command for similar syntax. **GOVP2** is for dual channel models only.

**Example:**

**GOVP ON**

Sets all the power supplies' OVP state to ON.

## **GOC/GOC2**

**Description:**

Configures/Queries the over current protection value of all the power supplies connected in the chain. See **OISSET/OISSET2** command for similar syntax. **GOC2** is for dual channel models only.

**Example:**

**GOC 3.000**

Sets all the power supplies' OCP value to 3.000 A.

## **GOCP/GOCP2**

**Description:**

Configures/Queries the over current protection state of all the power supplies connected in the chain. See **OCP/OCP2** command for similar syntax. **GOCP2** is for dual channel models only.

**Example:**

**GOCP ON**

Sets all the power supplies' OCP state to ON.

## **Error List**

Using any of the commands for multi unit programming for configuration, a response string is returned. If the command was sent successfully to the power supply(s) (except for **Synchronous**

**Control Commands**), the return string will be “**OK**”. If otherwise, an error message will occur. See the table below for the list of errors and their descriptions.

**Table 10- Error List for Multi Unit Programming**

<b>Return String</b>	<b>Description</b>
Time out	Wait response time has timed out
Range error	Input value is out of range
Multi master	More than one master is in the chain.

## 5 Troubleshooting Guide

Below are some frequently asked questions and answers. Please check if any applies to your power supply before contacting B&K Precision.

### ***General***

**Q: I cannot power up the power supply.**

- Check that the power cord is securely connected to the AC input and there is live power from your electrical AC outlet.
- Check that the correct fuse is inserted into the fuse box in the rear panel, and the line voltage switch is selected to the appropriate voltage. See section “2.1” and “2.2” for details.

**Q: I cannot access the menu when pressing the MENU button.**

- Check that the outputs are OFF (disabled).
- Check to make sure the instrument is not in remote mode, as indicated by the RMT LED indicator.

**Q: How do I setup the supply to run in constant current mode?**

- The supply is a CV/CC power supply that automatically crosses over from CV to CC upon a load which draws current at the current limit (ISET). Therefore, it is dependent on the load. For example, if ISET is configured as 1 A, the load must draw 1 A before the supply will go into CC mode.

**Q: How come my display voltage is lower than the voltage I set?**

- This is often because of the resistances from the test leads/wires connected between the supply and the DUT (device

under test), which causes a drop in voltage. To minimize this drop, use remote sense terminals to compensate and output a more accurate voltage to the DUT.

**Q: On my dual channel power supply, how do I set a timer output for each channel?**

- The two channels are dependent on the same timer function. Therefore, when used it will affect both outputs.

**Q: I want to use the external analog control from the DIO/Analog interface card. However, I only want to adjust voltage.**

- The external analog control requires that both voltage and current analog controls are connected to either an external DC voltage or resistance. If only the voltage input terminals are connected, current will remain set to 0 A, and thus output will be 0. Two sources (DC voltage or resistance) must be used simultaneously to function properly; one for voltage and one for current.

**Q: I cannot set voltage or current at the maximum rating.**

- Go into the menu and check the **OUTPUT SETTINGS** to verify that the **VOLT LIMIT SETTING** and **CURR LIMIT SETTING** are configured within the range you want to adjust.
- Verify the protection settings under the **PROTECTION** menu to make sure OVP and OCP settings are configured to the maximum value or greater than the voltage and current value you want to adjust.

## ***Remote Control***

**Q: I am trying to send the commands over USB/RS232, but it does not seem to respond.**

- Check that you are sending ASCII strings that are terminated with a CR (carriage return) and LF (linefeed) character.
- For USB, check that the correct USB drivers are installed and that you are communicating with the right COM port, which can be verified under “Device Manager” in Windows.
- For USB and RS232, be sure to use 57600 baudrate, no parity, 8 data bits, 1 stop bit, no flow control setting.

**Q: Can I use RS485 to control multiple power supplies instead of via USB if my PC has an RS485 interface port?**

- Yes. Please contact B&K Precision for details.

## 6 Specifications

**Note:** All specifications apply to the unit after a temperature stabilization time of 15 minutes over an ambient temperature range of  $23\text{ }^{\circ}\text{C} \pm 5\text{ }^{\circ}\text{C}$ . Specifications are subject to change without notice.

Model	9171	9172
<b>Output Rating</b>		
Low Range	0–10V/0 -10A	0–35V/0–3A
High Range	0–20V/0–5A	0–70V/0 – 1.5A
Output Channel	1	
Output Power	100W	105W
<b>General</b>		
Maximum Rated Input Power	230VA	
Dimension(W*H*D)	210mmx87mmx414mm	
Weight	7kg	

Model	9173	9174
<b>Output Rating</b>		
Low Range	0–10V/0–10A	0–35V/0–3A
High Range	0–20V/0–5A	0–70V/0– 1.5A
Output Channel	2	
Output Power	200W	210W
<b>General</b>		
Maximum Rated Input Power	460VA	
Dimension(W*H*D)	210mmx130.5mmx415mm	
Weight	10.5kg	

<b>Model</b>	<b>9181</b>	<b>9182</b>
<b>Output Rating</b>		
Low Range	0–18V/0–8A	0–10V/0–20A
High Range	0–36V/0–4A	0–20V/0–10A
Output Channel	1	
Output Power	144W	200W
<b>General</b>		
Maximum Rated Input Power	230VA	680VA
Dimension(W*H*D)	210mmx87mmx414mm	210mmx130.5mmx415mm
Weight	7.7kg	12kg

<b>Model</b>	<b>9183</b>
<b>Output Rating</b>	
Low Range	0–35V/0–6A
High Range	0–70V/0–3A
Output Channel	1
Output Power	210W
<b>General</b>	
Maximum Rated Input Power	510VA
Dimension(W*H*D)	210mmx130.5mmx415mm
Weight	11kg

<b>Model</b>	<b>9184</b>	<b>9185</b>
<b>Output Rating</b>		
Low Range	0–100V/0–2A	0–400V/0– 0.5A
High Range	0–200V/0–1A	0–600V/0– 0.35A
Output Channel	1	
Output Power	200W	210W

<b>General</b>	
Maximum Rated Input Power	510VA
Dimension(W*H*D)	210mmx130.5mmx415mm
Weight	10.5kg

**Note: The specifications below apply to all models in the series. Some specifications have model number(s) in ( ) to indicate which model(s) they apply to.**

<b>Line Regulation</b>	
Voltage	$\leq 0.01\% + 1\text{mV}$
Current	$\leq 0.01\% + 250\mu\text{A}$
<b>Load Regulation<sup>1</sup></b>	
Voltage	$\leq 0.01\% + 1\text{mV}$
Current	$\leq 0.01\% + 250\mu\text{A}$
<b>Ripple and Noise (20Hz-20MHz)</b>	
Normal Mode Voltage	$\leq 0.35\text{mVrms}/\leq 3\text{mVpp}$ (9171,9173,9181,9182)
	$\leq 0.5\text{mVrms}/\leq 5\text{mVpp}$ (9172,9174,9183)
	$\leq 1.5\text{mVrms}/\leq 15\text{mVpp}$ (9184)
	$\leq 4.5\text{mVrms}/\leq 45\text{mVpp}$ (9185)
Normal Mode Current	$\leq 2\text{mA rms}$
Common Mode Current	$\leq 1.5\mu\text{A rms}$
<b>Resolution</b>	
Programming and Readback	$<1\text{mV}/<1\text{mA}$ (9171,9173,9181,9182)
	$<2\text{mV}/<0.1\text{mA}$ (9172,9174)
	$<2\text{mV}/<0.2\text{mA}$ (9183)
	$<10\text{mV}/<0.1\text{mA}$ (9184)
	$<20\text{mV}/<0.01\text{mA}$ (9185)



<b>Programming and Readback Accuracy <math>\pm</math>(% output+offset)</b>	
Voltage	$\leq 0.05\%+5\text{mV}$ (9171,9173,9181, 9182) $\leq 0.05\%+10\text{mV}$ (9172,9174,9183) $\leq 0.05\%+50 \text{ mV}$ (9184) $\leq 0.05\%+100\text{mV}$ (9185)
Current	$\leq 0.1\%+2\text{mA}$ (9171,9173,9181,9183) $\leq 0.1\%+1\text{mA}$ (9172,9174,9184) $\leq 0.1\%+5 \text{ mA}$ (9182) $\leq 0.1\%+0.1 \text{ mA}$ (9185)
<b>Temperature Coefficient per <math>^{\circ}\text{C}</math> <math>\pm</math>(% output+offset)</b>	
Voltage	$\leq 0.005\%+1\text{mV}$ $\leq 0.005\%+10 \text{ mV}$ (9184) $\leq 0.005 \text{ \%}+20 \text{ mV}$ (9185)
Current	$\leq 0.01\%+3\text{mA}$
<b>Stability (8 hrs) <math>\pm</math>(% output+offset)</b>	
Voltage	$\leq 0.02\%+2\text{mV}$ $\leq 0.02 \text{ \%}+10 \text{ mV}$ (9184) $\leq 0.02\%+20 \text{ mV}$ (9185)
Current	$\leq 0.1\%+1\text{mA}$
Settling Time <sup>2</sup>	$\leq 30\text{ms}$
Measurement Time	$\leq 50\text{ms}$
Transient Response Time <sup>3</sup>	$\leq 50\mu\text{s}$ (9171 - 9183) $\leq 100\mu\text{s}$ (9184, 9185)
OVP Accuracy	$\leq 0.5\%+0.1\text{V}$ (9171 – 9183) $\leq 0.5\%+1\text{V}$ (9184, 9185)
OCP Accuracy	$\leq 0.5\%+0.1\text{A}$
OVP/OCP Activation Time <sup>4</sup>	$\leq 1\text{mS}$
Remote Sense Compensation	1V Max
Rising Time at Full Load	$\leq 8\text{mS}$ (9171,9173,9181,9182) $\leq 10\text{mS}$ (9172,9174,9183)

	$\leq 30\text{mS}$ (9184) $\leq 40\text{mS}$ (9185)
Rising Time at No Load	$\leq 8\text{mS}$ (9171,9173,9181,9182) $\leq 10\text{mS}$ (9172,9174,9183) $\leq 30\text{mS}$ (9184) $\leq 40\text{mS}$ (9185)
Falling Time at Full Load	$\leq 8\text{mS}$ (9171,9173,9181,9182) $\leq 10\text{mS}$ (9172,9174,9183) $\leq 30\text{mS}$ (9184) $\leq 40\text{mS}$ (9185)
Falling Time at No Load	$\leq 250\text{mS}$
Standard Interface	USB
Optional Interface Cards <sup>5</sup>	LAN/GPIB Card, Digital I/O and Analog Control Cards (1CH and 2CH), RS485 Card, RS232 Card
<b>General</b>	
AC Input	115/230 VAC $\pm$ 10%, 47Hz - 63Hz
Operating Temperature	0°C- 40°C
Storage Temperature	-10°C- 70°C

<sup>1</sup>With sense terminal connected.

<sup>2</sup>Maximum time required for the output voltage to change from 1% to 99% or vice versa following the receipt of VOLTage or VSET command via direct GPIB or USB interface.

<sup>3</sup>Models 9171 – 9183: Less than 50  $\mu\text{s}$  for output to recover to within 15 mV following a change in output current from full load to half load or vice versa.  
Model 9184: Less than 100  $\mu\text{s}$  for output to recover to within 50 mV following a change in output current from full load to half load or vice versa.

Model9185: Less than 100  $\mu\text{s}$  for output to recover to within 120 mV following a change in output current from full load to half load or vice versa.

<sup>4</sup>Average time for output to start to drop after OVP/OCV condition occurs.

<sup>5</sup>Digital I/O Analog Control Card Accuracy: $\pm$ 1%.

To ensure the most current version of this manual, please download the latest version here: <http://www.bkprecision.com/search/9171>

For current up-to-date product information, please visit [www.bkprecision.com](http://www.bkprecision.com)

# 7 Calibration

## *Access Calibration Menu*

Follow the steps below to access the calibration menu.

1. Press **Menu** , then **7** to enter **CALIBRATION**. The following screen will be displayed:



2. Enter the password: **13579** with the numeric keypad.
3. There will be two options. **1. CURRENT CALIBRATION**, and **2. VOLTAGE CALIBRATION**, as shown in the screen below. A third option **3. EXT. INPUT CALIB** is available if the supply has an optional **DIO/Analog Interface Card** installed.

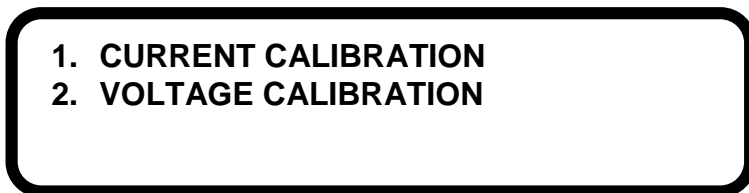

## *Requirements*

Before calibrating, the “+” output terminal must be connected to the “+S” terminal and the “-” output terminal must be connected to the

“-S” terminal using the included shorting bars/pins.

The following equipment is required for the calibration procedure:

- 6 ½ digit precision digital multimeter
- Shunt for current calibration (Necessary if the maximum output current of the power supply is greater than the maximum current the multimeter is capable of measuring)
- DC source with an output up to 10VDC and accuracy of at least  $\pm 0.1\%$  (for external analog input calibration)
- 5 k $\Omega$  resistor with accuracy within  $\pm 0.1\%$  or better (for external analog input calibration)

## Current Calibration

- If the maximum output current of the power supply is within the current limit of the DMM, then use the wire connections shown in Figure 31 to calibrate current.
- If the maximum output current of the power supply is greater than the current limit of the DMM, then a current shunt must be used. The wire connections between the power supply and the DMM will be setup like Figure 32.

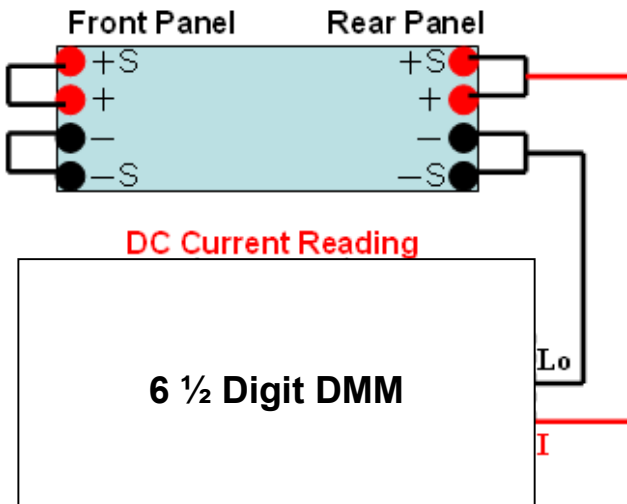

Figure 31 - Current Calibration Setup

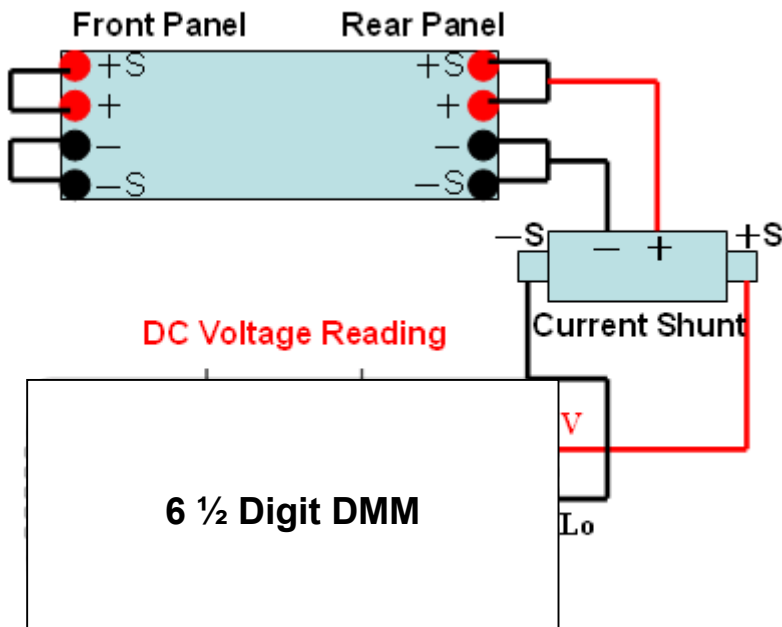

Figure 32- Current Calibration with Shunt

Follow the steps below to proceed with current calibration:

1. From the calibration menu, press **1** to enter **CURRENT CALIBRATION**. The following screen will be shown.

**CURRENT CALIBRATION CH: 1**  
**IL Set = X . XXXXA    Read = XXX**  
**IML Set = X . XXXXA    Read = XXX**

2. Select the channel (for dual channel models), then press **Enter**. The calibration process will automatically start.

3. The power supply will output a pre-set current to the DMM. Wait for the DMM reading to settle, then enter it into where it shows **IL Set = \_\_\_\_A** on the display. Press **Enter** to proceed to **IML**. If current shunt is used for the calibration, divide the DMM readings (in DCV) by the resistance (Rs) of the shunt. The result should be DCV/Rs. Enter this current result into **IL**.
4. The power supply will then pre-set another current value for **IML**. Repeat the same process in step 3. Once finished, repeat the same process for **IMH** and **IH**, as shown below.

**IMH Set = X . XXXXA    Read = XXXXX**  
**IH    Set = X . XXXXA    Read = XXXXX**  
**CALIB OCP Lo = ► Start**

**CALIB OCP Hi = ► Start**

5. Once finished, the **OCP Lo** calibration will begin. Press **Enter** to start. After it's complete, the unit will select **CALIB OCP Hi** for calibration. Again, after it's complete, press **Enter**.
6. Once this calibration process is complete, the calibration data will be stored into flash memory, and the supply will return to the calibration menu.

## Voltage Calibration

- Use the setup diagram shown in Figure 33 below for voltage calibration. Connect the rear output terminals of the power supply to the DMM.

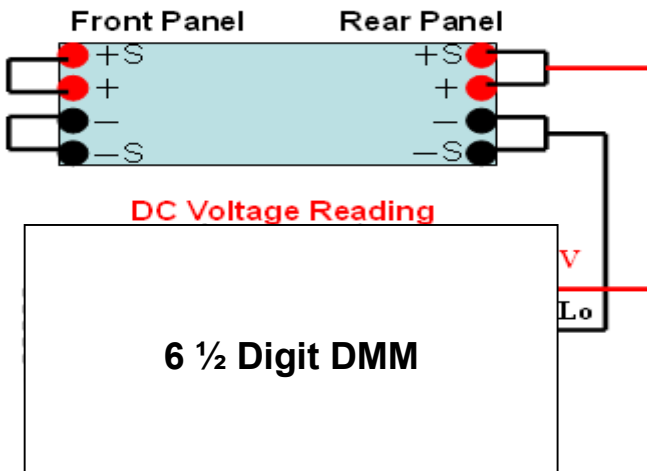



Figure 33- Voltage Calibration Setup

Follow the steps below to proceed with voltage calibration:



1. From the calibration menu, press **2** to enter **VOLTAGE CALIBRATION**. The following screen will be shown.

**VOLTAGE CALIBRATION CH: 1**  
**VL Set = X . XXXXV      Read = XXXX**  
**VML Set = XX . XXXXV      Read = XXXXX**

2. Select the channel (for dual channel models), then press  .  
The calibration process will automatically start.
3. The power supply will output a pre-set voltage to the DMM. Wait for the DMM reading to settle, then enter it into where it shows **VL Set = \_\_.\_\_\_\_V** on the display. Press  to proceed to the next setp.
4. The power supply will then pre-set another voltage value for **VML**. Repeat the same process in step 3. Once finished, repeat the same process for **VMH** and **VH**, as shown below.

**VMH Set = XX . XXXXV    Read = XXXXX**  
**VH    Set = XX . XXXXV    Read = XXXXX**  
**CALIB OVP Lo = ► Start**

**CALIB OVP Hi = ► Start**

5. Once finished, the **OVP Lo** calibration will begin. Press  to start. After it's complete, the unit will select **CALIB OVP Hi** for calibration. Again, after completion, press .
6. Once this calibration process is complete, the calibration data will be stored into flash memory, and the supply will return to the calibration menu.



## ***External Analog Input Calibration***

This calibration option is only available if the optional **DIO/Analog Interface Card** is installed in the power supply.

Follow the steps below to proceed with external analog input calibration.

1. From the calibration menu, press **3** to enter **EXT. INPUT CALIB**. If the single channel **DIO/Analog Interface Card** is installed, then Figure 34 will be shown. If the dual channel version is installed, Figure 35 will be displayed.

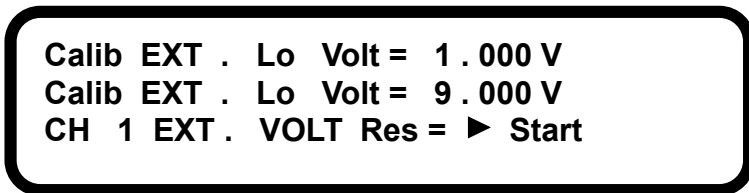

Calib EXT . Lo Volt = 1 . 000 V  
Calib EXT . Lo Volt = 9 . 000 V  
CH 1 EXT . VOLT Res = ► Start

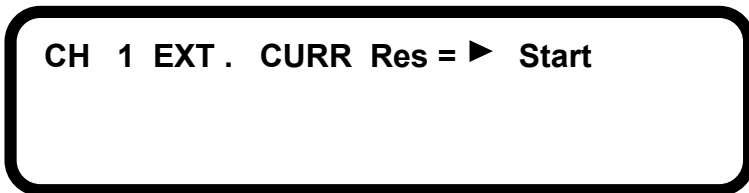

CH 1 EXT . CURR Res = ► Start

**Figure 34- Single Channel External Analog Input Calibration**

Calib EXT . Lo Volt = 1.000 V  
 Calib EXT . Lo Volt = 9.000 V  
 CH 1 EXT . VOLT Res = ► Start

CH 1 EXT . CURR Res = ► Start  
 CH 2 EXT . VOLT Res = ► Start  
 CH 2 EXT . CURR Res = ► Start

Figure 35- Dual Channel External Analog Input Calibration

2. Connect the 10VDC source to the analog inputs on the **DIO/Analog Interface Card** as shown in Figure 36 for single channel.

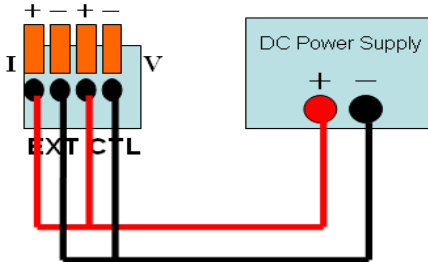
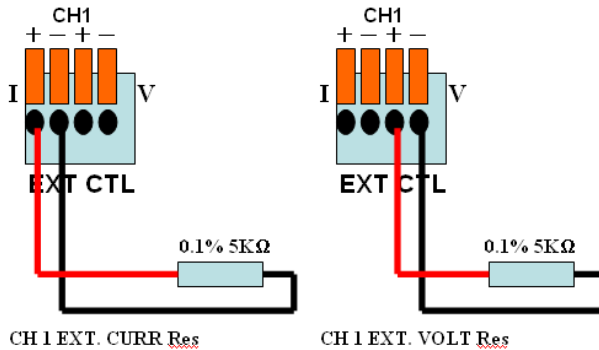

Figure 36- Single Channel Analog Control Calibration Setup

3. Set the DC source to output 1.000 V and wait for approximately 5 seconds until the output voltage is stable. Press **Enter** to finish the first step.
4. Next, change the output of the DC source to 9.000 V and follow the same as step 3.

- To begin calibration with the external resistor, remove the DC source and connect the precision resistor to the control card, as shown in Figure 37(right) below.



**Figure 37- External Resistance Control Calibration setup (left) Current (right) Voltage**

- The supply will display **CH1 EXT. VOLT Res**. Press **Enter** to calibrate.
- Once finished, **CH1 EXT. CURR Res** will be selected. Connect the precision resistor as shown in Figure 37(left). Press **Enter** to proceed with the calibration.
- (Dual channel) The calibration process for the dual channel **DIO/Analog Interface Card** is similar to the above steps for single channel, with the exception of repeating steps 3-7 twice.
- (Dual channel) For the external voltage calibration, connect the leads like Figure 38 shown below.

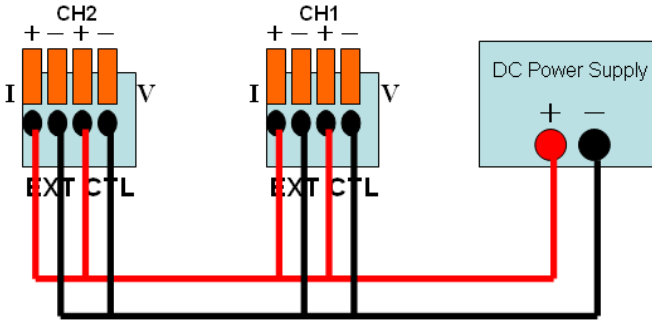

Figure 38- Dual Channel External Analog Voltage Input Calibration Setup

10. (Dual channel) For the external resistor calibration, connect like for channel 1 for current and voltage, and connect like for channel 2 for current and voltage.
11. Once finished, the supply will return to the calibration menu. To exit and go back to the main display, press **Esc** twice.

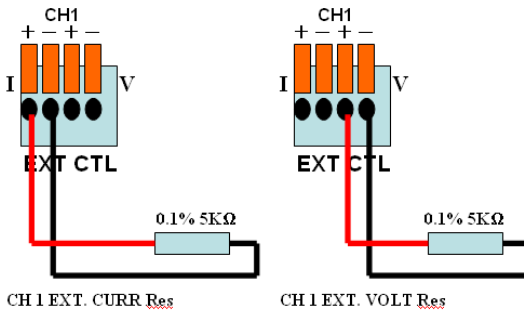
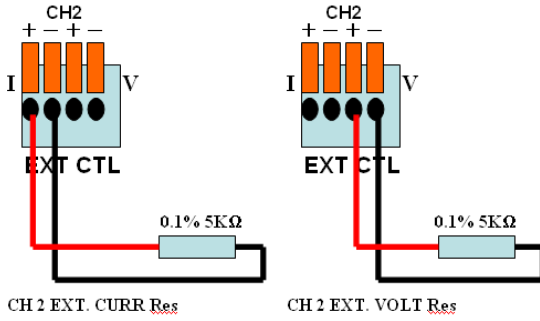

Figure 39- Channel 1 Setup for External Analog Resistor Input Calibration



**Figure 40- Channel 2 Setup for External Analog Resistor Input Calibration**

# Index

- AC input, 18
- Calibration, 158
- CHAIN SETTING**, 38
- Current Limit, 44
- Digital I/O**, 77
- Dual Channel, 49, 55
- Enable/Disable Output, 49
- errors, 81
- Ethernet (LAN), 34, 88
- External Analog Control, 72
- Factory Default, 41
- Firmware Version, 27
- Fuse, 18
- GPIO, 34
- GPIO:DIR**, 79
- Install Interface Cards, 11
- Interface Card, 8
- Key Lock, 39
- Key Sound, 40
- LCD BACKLIT**, 39
- LED Mode, 62
- Line Voltage Switch**, 20
- Measurement Averag, 55
- Menu, 28
- Multi Unit Programming, 138
- OCP, 67
- Output Timer, 53
- OVP, 66
- Power-On State, 70
- Rackmount, 9
- rear output terminals, 21
- Recall, 70
- Remote Commands, 91
- Remote Sense, 57
- Resistance, 74
- RMT**, 32
- RS-232, 35
- RS-485, 36, 138
- Save, 68
- SCPI, 92
- Self Test**, 23
- Sequence Program, 71, 134
- Series/Parallel Tracking, 56
- Setting Current, 47
- Setting Voltage, 45
- Slew Rate, 51, 105, 106
- Socket, 90
- Specifications, 153
- STATUS?**, 131
- Telnet, 88
- Troubleshooting, 150
- USB Interface, 32
- Voltage Limit, 43
- Web Server, 85

# SERVICE INFORMATION

---

**Warranty Service:** Please go the support and service section on our website [www.bkprecision.com](http://www.bkprecision.com) to obtain a RMA #. Return the product in the original packaging with proof of purchase to the address below. Clearly state on the RMA the performance problem and return any leads, probes, connectors and accessories that you are using with the device.

**Non-Warranty Service:** Please go the support and service section on our website [www.bkprecision.com](http://www.bkprecision.com) to obtain a RMA #. Return the product in the original packaging to the address below. Clearly state on the RMA the performance problem and return any leads, probes, connectors and accessories that you are using with the device. Customers not on an open account must include payment in the form of a money order or credit card. For the most current repair charges please refer to the service and support section on our website.

Return all merchandise to B&K Precision Corp. with pre-paid shipping. The flat-rate repair charge for Non-Warranty Service does not include return shipping. Return shipping to locations in North America is included for Warranty Service. For overnight shipments and non-North American shipping fees please contact B&K Precision Corp.

B&K Precision Corp.  
22820 Savi Ranch Parkway  
Yorba Linda, CA 92887  
[www.bkprecision.com](http://www.bkprecision.com)  
714-921-9095

**Include with the returned instrument your complete return shipping address, contact name, phone number and description of problem.**

# LIMITED THREE-YEAR WARRANTY

---

B&K Precision Corp. warrants to the original purchaser that its products and the component parts thereof, will be free from defects in workmanship and materials for a period of three year from date of purchase.

B&K Precision Corp. will, without charge, repair or replace, at its option, defective product or component parts. Returned product must be accompanied by proof of the purchase date in the form of a sales receipt.

To help us better serve you, please complete the warranty registration for your new instrument via our website [www.bkprecision.com](http://www.bkprecision.com)

**Exclusions: This warranty does not apply in the event of misuse or abuse of the product or as a result of unauthorized alterations or repairs. The warranty is void if the serial number is altered, defaced or removed.**

B&K Precision Corp. shall not be liable for any consequential damages, including without limitation damages resulting from loss of use. Some states do not allow limitations of incidental or consequential damages. So the above limitation or exclusion may not apply to you.

This warranty gives you specific rights and you may have other rights, which vary from state-to-state.

B&K Precision Corp.  
22820 Savi Ranch Parkway  
Yorba Linda, CA 92887  
[www.bkprecision.com](http://www.bkprecision.com)  
714-921-9095









22820 Savi Ranch Parkway  
Yorba Linda, CA92887  
[www.bkprecision.com](http://www.bkprecision.com)

© 2014 B&K Precision Corp.